



Fashion Final collection Portfolio

The ghost of mind



Q1
Concept

C
O

Q2
Key Research

Q3
Colours and fabrics

N
T

Q4
Process

Q5
Illustrations

N
T

Q6
CAD Sheets

Q7
Photoshoot

S

Concept

Beneath every human being there is a huge void, unable to feel itself and insatiable with the feeling of acceptance of those around us. Everyone suppresses part of their feelings, the ones we believe are undesirable or inadequate, that part of ourselves we hide to the world due to the fear of being shunned because of them.

It's a form of emotional regulation, a way to keep ourselves at bay of our own selves, as a defence mechanism from emotional harm, leading to unwanted circumstances for those whose only way out is to resort to this. Suppressed emotions can lead to mental chaos, like an old ball and chain attached to our inner turmoil, causing these individuals to appeal to unhealthy coping strategies, like substance abuse or self harm.

All this information that drenches inside of my mind translates itself from within in form of garments. As fashion is not about only about looking good on our garments, but to feel comfortable with our own selves while we wear them.

Everyone gets lost on other people expectations, when the only expectation that really matters is your own.

This collection is based on the concept of suppressing feelings, the hunchback symbolizes everything we keep to ourselves before it explodes and the straight jackets the strings around our real feelings, unable to shine due to our own fears and insecurities. This collection is a wake up call for those stuck on their own fears, as a way to make them realize that their real selves shine brighter despite being sealed on their minds.

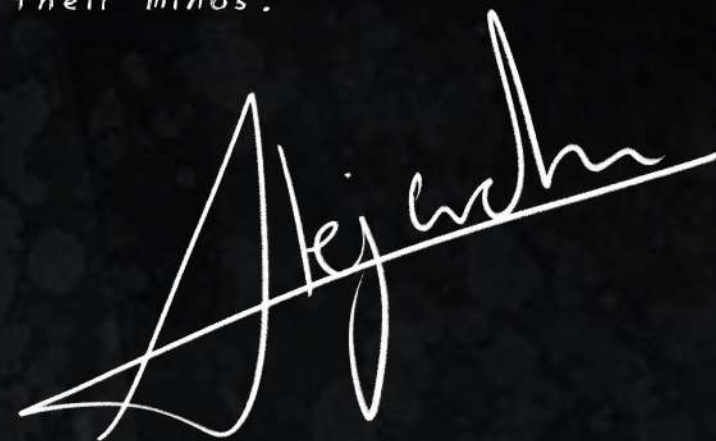

THE REAL
BEAUTY IS
INSIDE OURSELVES

PULL OUT
THE STRINGS
AROUND YOU

MIND
STRINGS

CROSSED
SLEEVES

BELTS

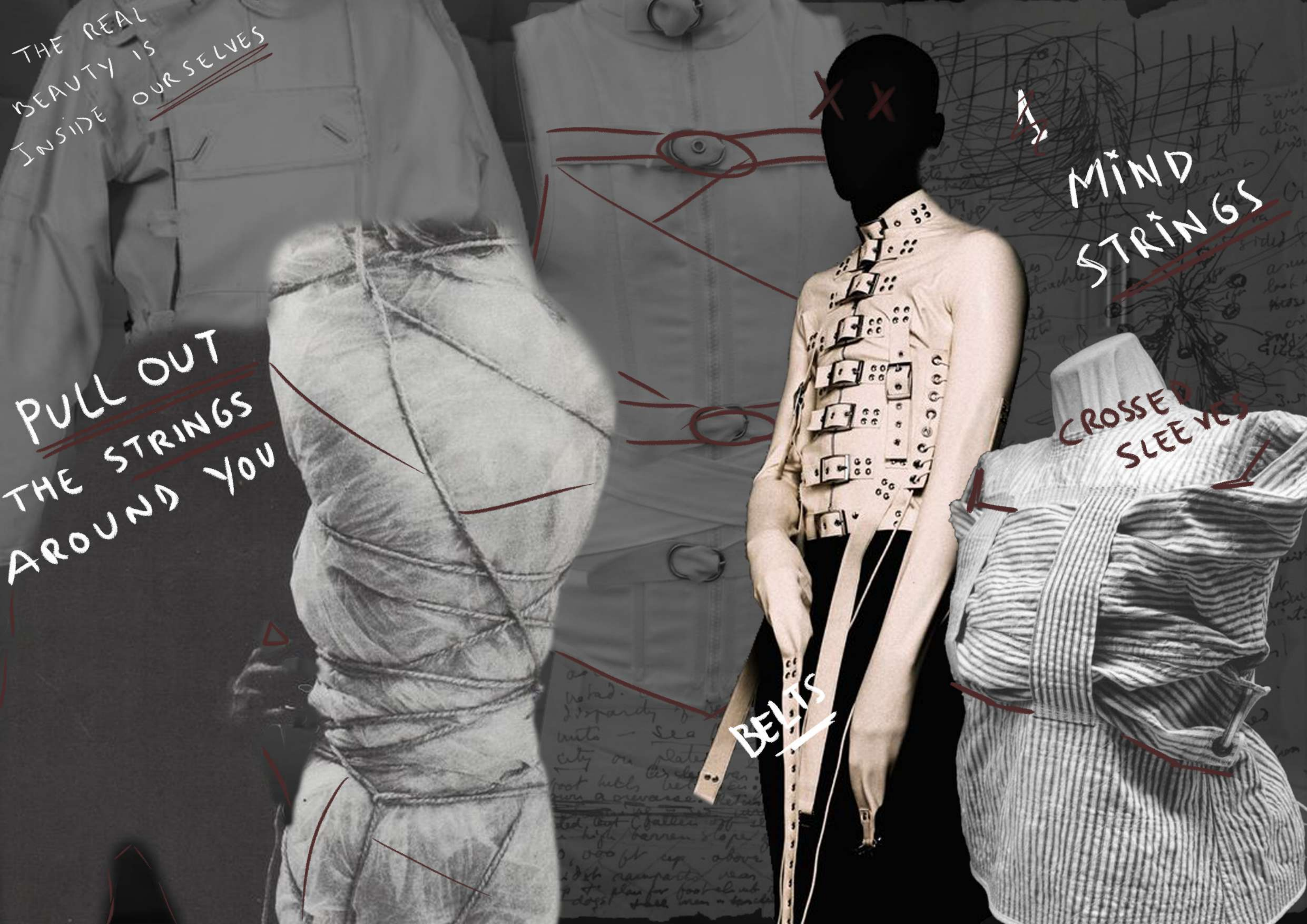

REPRESSION

PADDLED
HUNCHBACK

INSANITY
BEAUTY



#fbe816



#000000



#8d7b60



Colour Palette

#dccaab



#572828



#ffffff





Waterproof
100% polyester #FFD966

Lining
100% polyester #000000

Liner
50% Cotton 50% Polyester
#000055

Twill
100% cotton #A53829

Knit
100% cotton #000000

Twill
100% cotton #581020

Lining
100% polyester #000000

Knit
100% cotton #000000

Waterproof
100% polyester #FFD966

Lining
100% polyester #000000

Twill
100% cotton #FFFFFF

Twill
100% cotton #A53829

Twill
100% cotton #A53829

Waterproof
100% polyester #FFD966

Twill
100% cotton #FFFFFF

Silk
100% silk
#FFFFFF and #000000

66

63



60

57

54

51

Knit
95% polyester 5% elastane
#000000

Lining
100% polyester #FFFFFF

Pique
100% cotton #FFFFFF

Knit
70% acrylic 30% polyester
#605F05

OUTFIT ~~A~~

The hunchback symbolizes all the emotions and feelings we repress and accumulate on our mind the moment before we explode

POLYESTER LINING

WATERPROOF

HUNCHBACK





LINEN

1 OUTFIT & 2

COTTON KNIT

31208

COTTON TWILL

The straight jackets and the crossed sleeves symbolizes the strings that we tie to suppress our own feelings

COTTON
ELASTIC
KNIT

COTTON
TWILL

COTTON
ELASTIC
KNIT

The blazer fit symbolizes the beauty while the corset closure and the overlapped straps the feelings of repression we have towards ourselves

OUTFIT 3

BLAZER
FIT

CORSET
CLOSURE

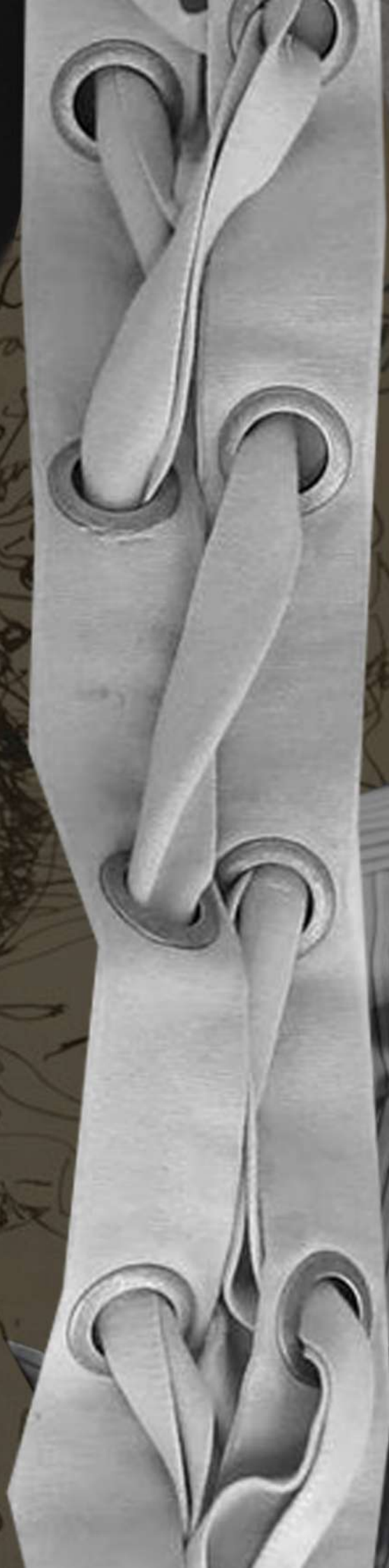

OVERLAPPED
STRAPS



Resembling the padded rooms and the feeling of confinement with the padded sleeves and the corsets as a way to show that the supresion of our feelings is only locking up our real beauty

POLYESTER LINING

WATERPROOF

COTTON PIQUE



PAISLEY

OUTFIT

CORSET

STRAP

GARMENT 1

The Asylum Hunchback

This garment is inspired on the supression of feelings, where the shape of the hunchback symbolizes those supressed feelings and how they affect our minds is portrayed into the straight jacket inspired shirt and pants, where the sleeves crossing in front of the garment are the padlocks of our true self.



GARMENT 11



The prisoner overall

This garment is inspired on the end of the line of a mental illness, where you are thrown into a ward and your only ally is yourself.

The overall represents the maximum point of suppression, where you feel a prisoner of your own mind, while the jersey with the long sleeves represent the inability of helping yourself while the madness consume you.

GARMENT III

The asylum maiden

This garment represents the process of healing and the fact that we should be proud of our own selves. All the imperfections of the dress were done in purpose to portray the imperfections of human mind. The blazer represents that life is not always about being perfect, but to enjoy our own beauty and imperfections.



GARMENT IIII

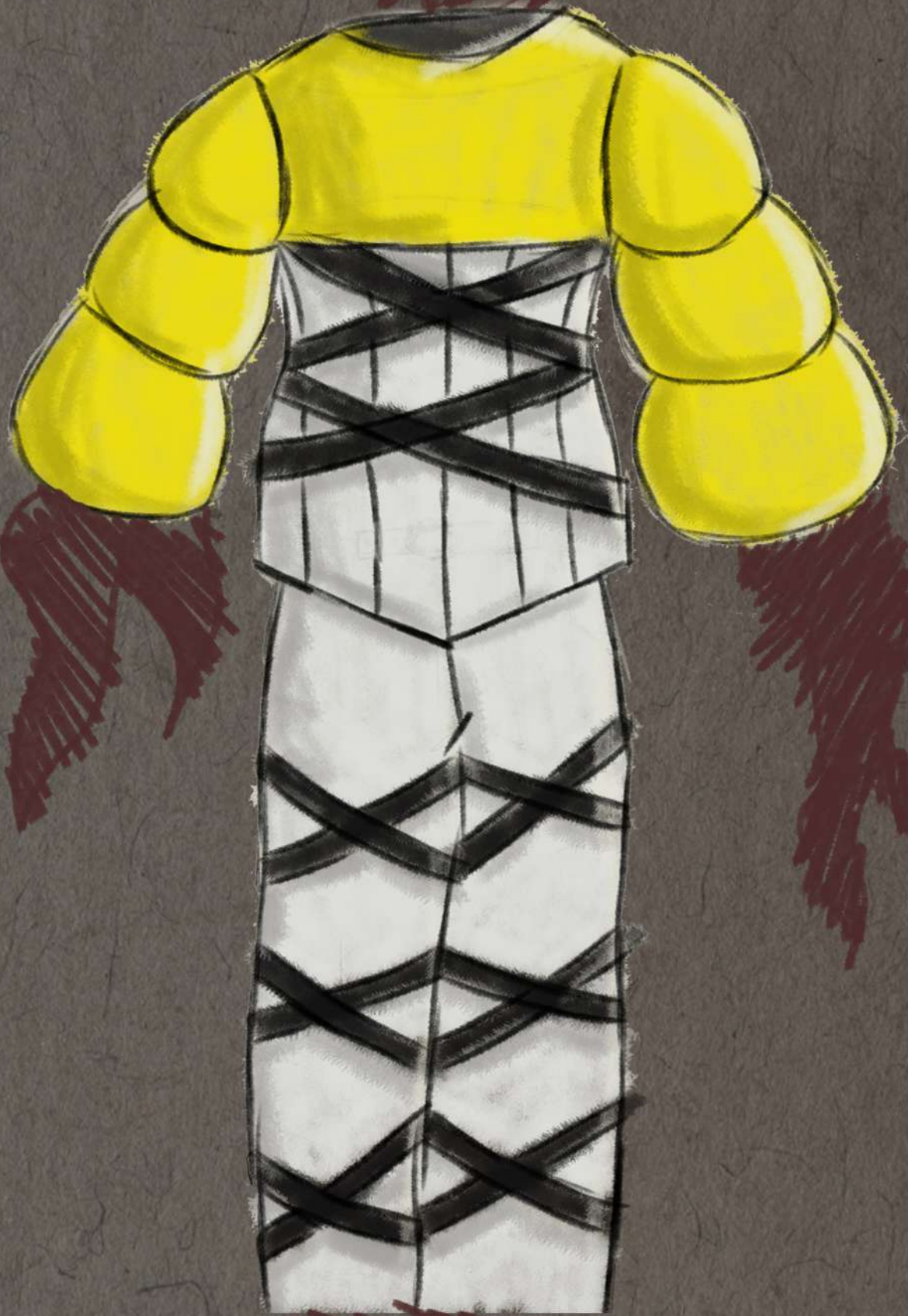

The ghost of mind

This garment represents the ghost of a sick mind. The corset and the pants with the black straps around it showcase the new self slowly removing the chains of the suppressed feelings. The bright padded sleeves portray a padded room, where the human mind lands at its lowest point. That room acts as a reminder that we have to keep taking care of our selves if we don't want to fall into madness.

Specifications

Fabric

Season	2023
Code	Final Collection
Date	21/05/2023
Supplier	UCA
Designer	Alejandro Darriba
Sample size	M

Waterproof Fabric
Yellow



Polyester Lining
Black



Stitching chart

1cm to edge



0,5 cm to edge



Notes

The coat lining pieces are stitched 1cm to edge, and reversibly stitched to the main fabric piece.

The grey part is the lining and the white part is the main fabric

Inner lining stitched 1cm to edge, and reversibly stitched to the main body

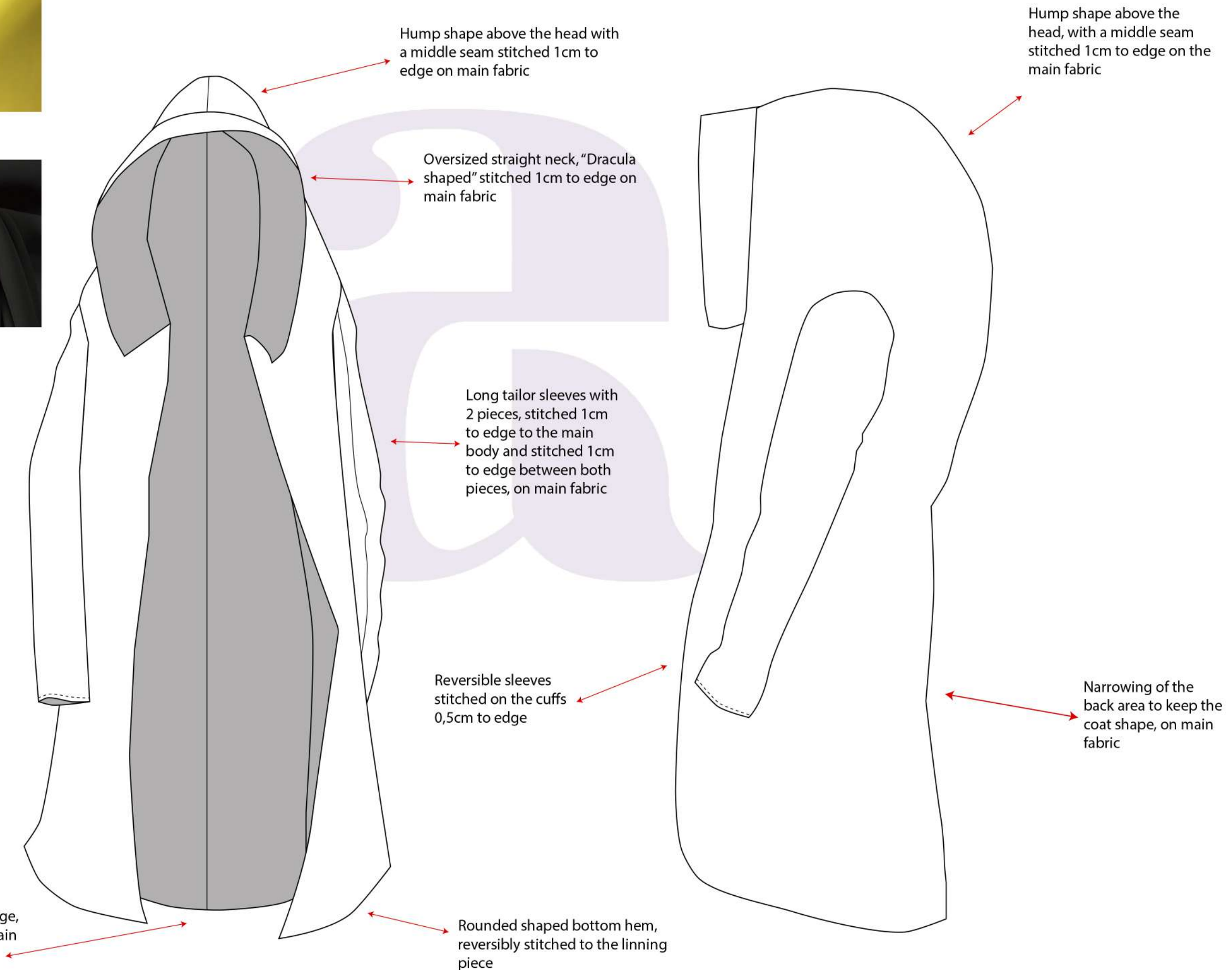

Measurements

Season	2023
Code	Final Collection
Date	21/05/2023
Supplier	UCA
Designer	Alejandro Darriba
Sample size	M

Fabric



Main Fabric:
100% Polyester
#FFD700



Lining:
100% Polyester
#000000

Thread positions and types

Yellow cotton thread
Stitched 1cm to edge on the main body
Stitched 0,5cm to edge on the sleeve cuffs

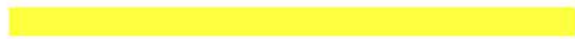

Black cotton thread
Stitched 1cm to edge on the lining pieces

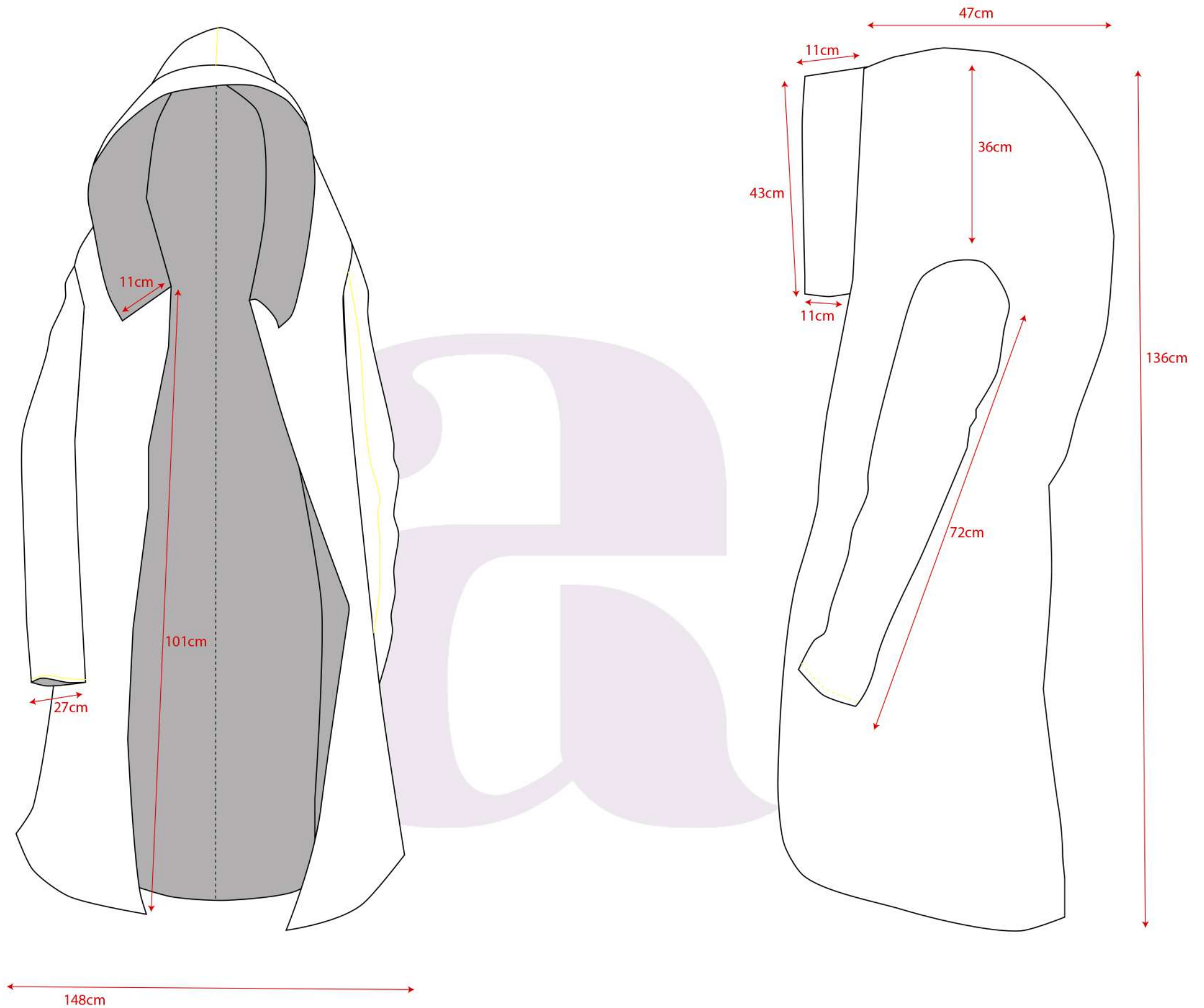

Breakdown

Details and trimmings

Season	2023
Code	Final Collection
Date	21/05/2023
Supplier	UCA
Designer	Alejandro Darriba
Sample size	M

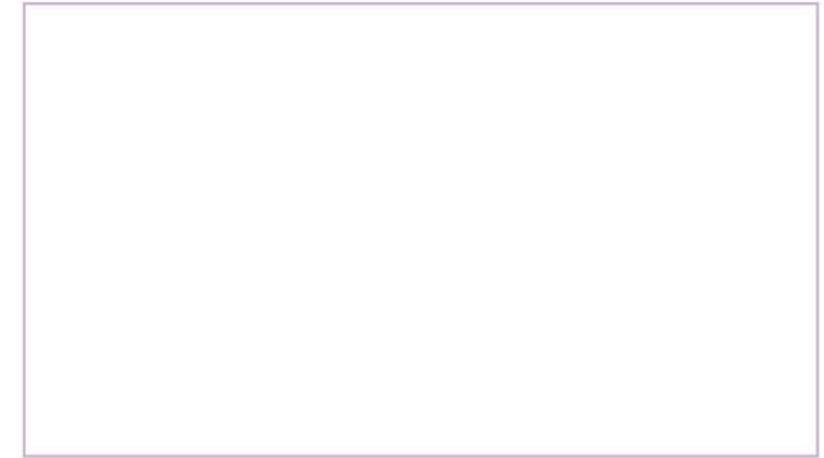
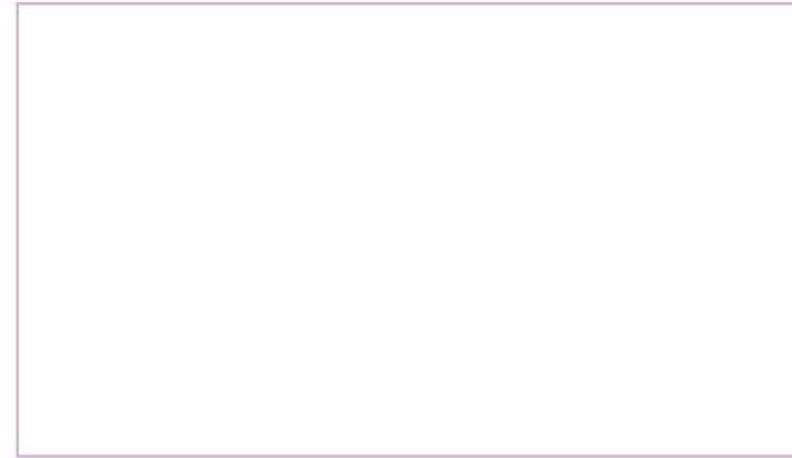
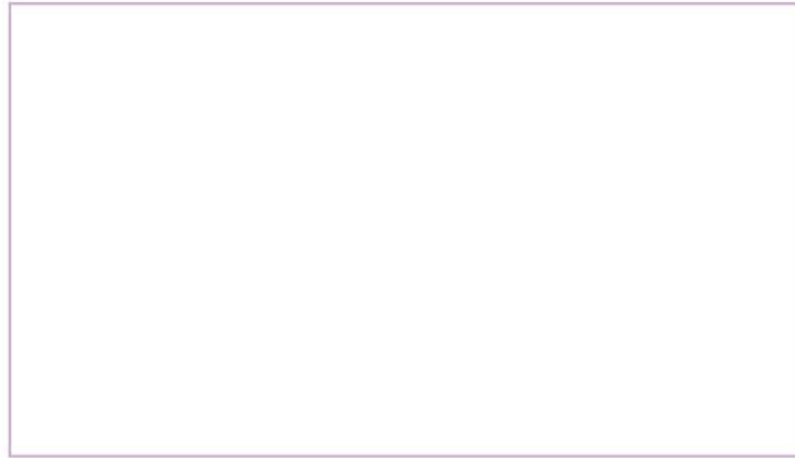

Descriptions

Hump shape above the head with a middle seam stitched 1cm to edge on main fabric

Oversized straight neck, "Dracula shaped" stitched 1cm to edge on main fabric

Long tailor sleeves with 2 pieces, stitched 1cm to edge to the main body and stitched 1cm to edge between both pieces, on main fabric

Reversible sleeves stitched on the cuffs 0,5cm to edge

Inner lining stitched 1cm to edge, and reversibly stitched to the main body

Rounded shaped bottom hem, reversibly stitched to the lining piece

Narrowing of the back area to keep the coat shape, on main fabric

Fabric	Placement	Colour
Waterproof	Main body, neck piece and sleeves	#FFD700
Polyester lining	Main lining, neck lining piece and sleeves lining	#000000

Trims	Placement	Colour

Thread	Placement	Colour
Cotton thread	Main body, neck piece, sleeves and sleeve cuffs	#FFD700
Cotton thread	Main lining, neck lining piece and sleeves lining	#000000

Specifications

Fabric

Linen fabric
Dulux Linen colour



Season	2023
Code	Final Collection
Date	21/05/2023
Supplier	UCA
Designer	Alejandro Darriba
Sample size	M

Stitching chart

1cm to edge

0,5 cm to edge

1cm double stitched to edge

Notes

All the borders of the garment are stitched 0,5cm to the inside to give the image of a raw finished

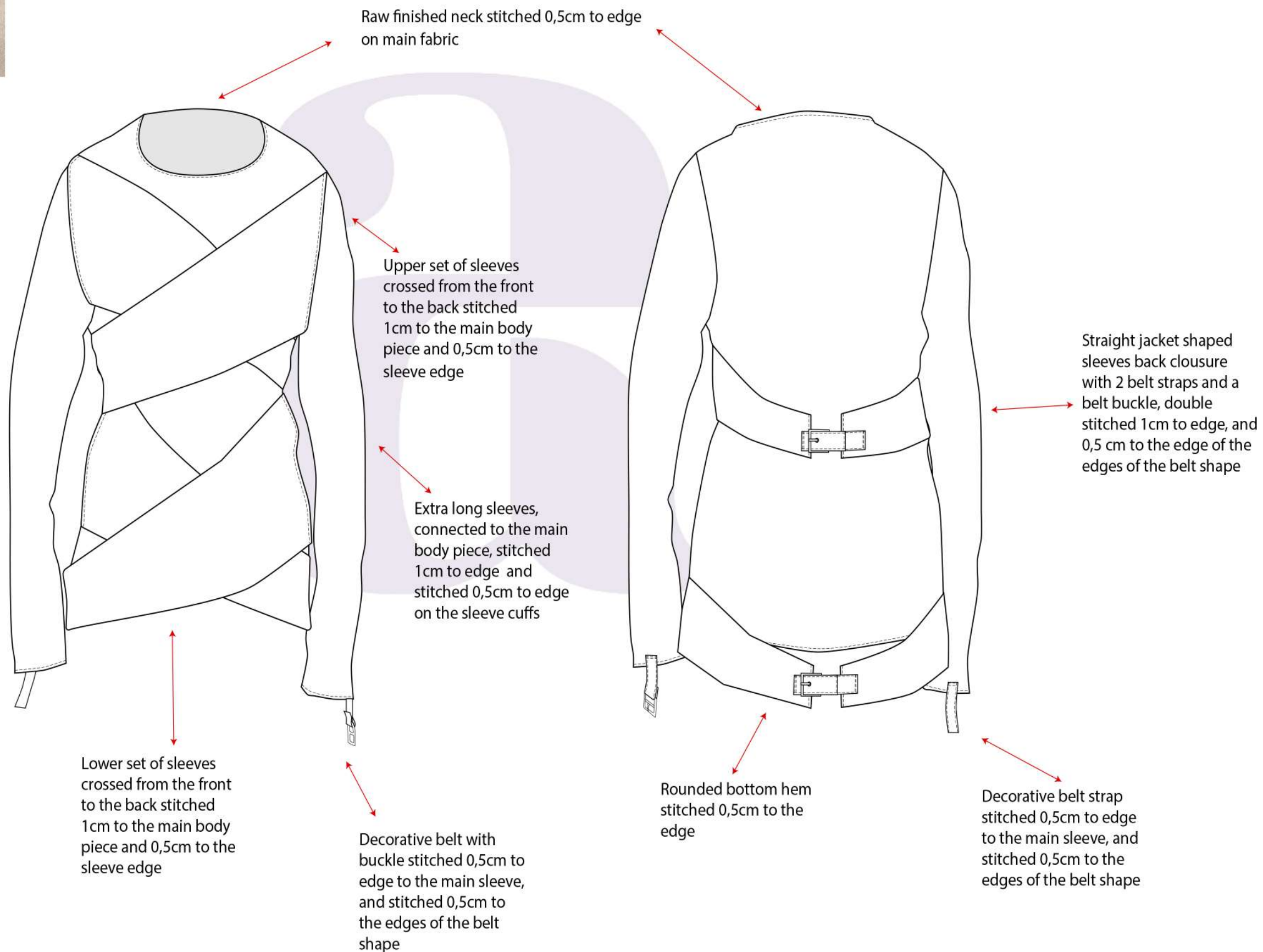

Measurements

Season	2023
Code	Final Collection
Date	21/05/2023
Supplier	UCA
Designer	Alejandro Darriba
Sample size	M

Fabric



Main Fabric:
50% Cotton, 50% Polyester
#DDD5B7

Thread positions and types

Dulux colour cotton thread
Stitched 1cm to edge on the main body
Stitched 0,5cm to edge on the sleeve cuffs and the straight jacket sleeves borders
Stitched 0,5 cm to edge on the neck and the bottom hem

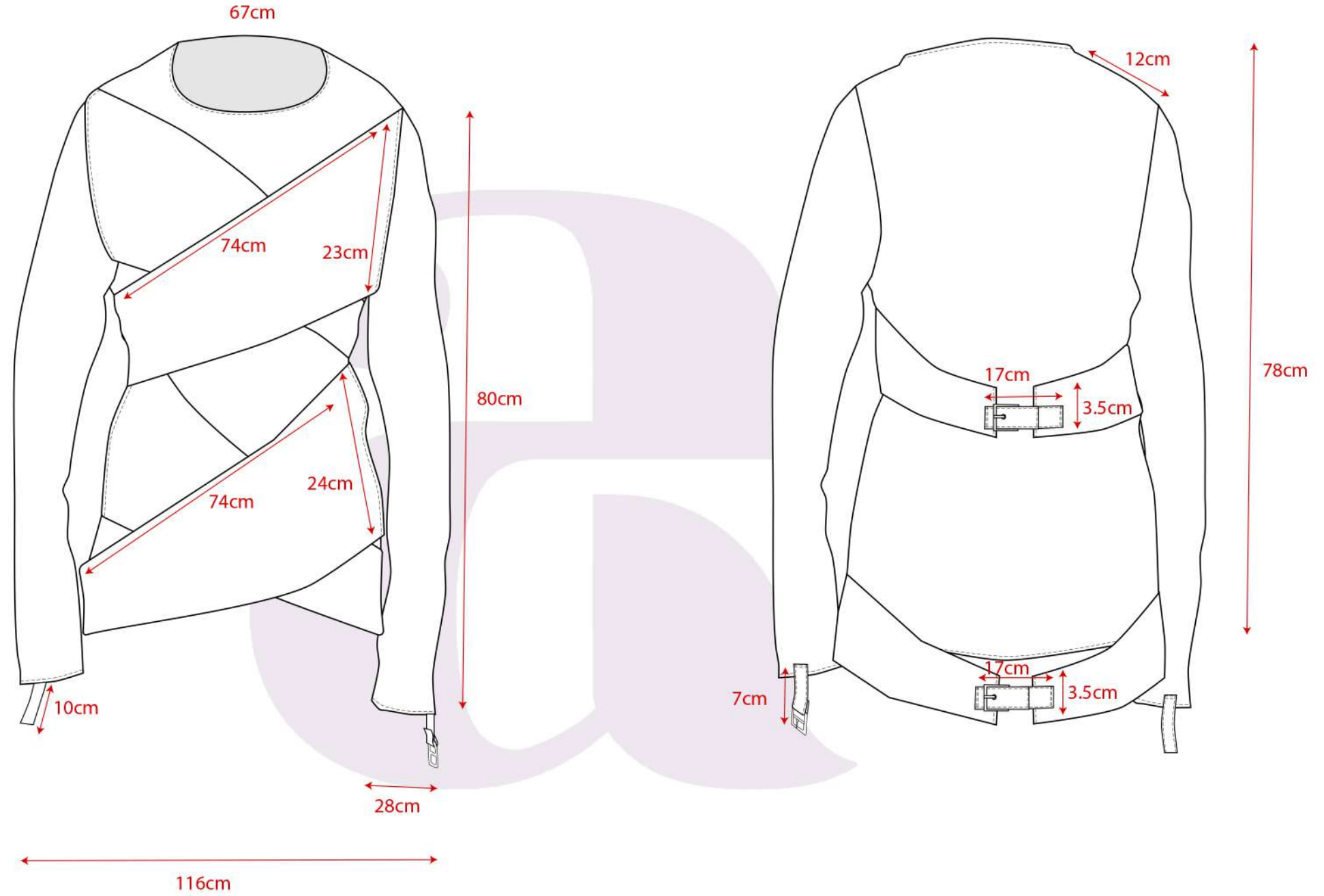

Breakdown

Details and trimmings

Season	2023
Code	Final Collection
Date	21/05/2023
Supplier	UCA
Designer	Alejandro Darriba
Sample size	M

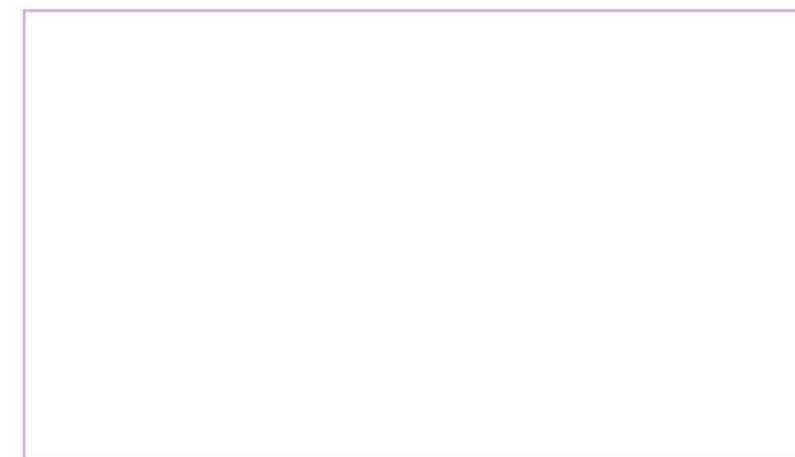

Descriptions

Raw finished neck stitched 0,5cm to edge on main fabric

Upper set of sleeves crossed from the front to the back stitched 1cm to the main body piece and 0,5cm to the sleeve edge

Extra long sleeves, connected to the main body piece, stitched 1cm to edge and stitched 0,5cm to edge on the sleeve cuffs

Decorative belt with buckle stitched 0,5cm to edge to the main sleeve, and stitched 0,5cm to the edges of the belt shape

Lower set of sleeves crossed from the front to the back stitched 1cm to the main body piece and 0,5cm to the sleeve edge

Rounded bottom hem stitched 0,5cm to the edge

Decorative belt strap stitched 0,5cm to edge to the main sleeve, and stitched 0,5cm to the edges of the belt shape

Straight jacket shaped sleeves back clousure with 2 belt straps and a belt buckle, double stitched 1cm to edge, and 0,5 cm to the edge of the edges of the belt shape

Fabric	Placement	Colour
Linen	Main body, sleeves and belt straps	#DDD5B7

Trims	Placement	Colour
Metallic belt buckle	Sleeve belts and belt straps, and back clousures	#COCOC0 (SILVER)
Metallic belt eyelets	Sleeve belts and belt straps, and back clousures	#COCOC0 (SILVER)

Thread	Placement	Colour
100% Cottom thread	Main body, sleeves and belt straps	#DDD5B7

Specifications

Fabric

Linen fabric
Dulux Linen colour



Season	2023
Code	Final Collection
Date	21/05/2023
Supplier	UCA
Designer	Alejandro Darriba
Sample size	M

Stitching chart

1cm to edge

0,5 cm to edge

1cm double stitched to edge

Notes

All the borders of the garment are stitched 0,5cm to the inside to give the image of a raw finished

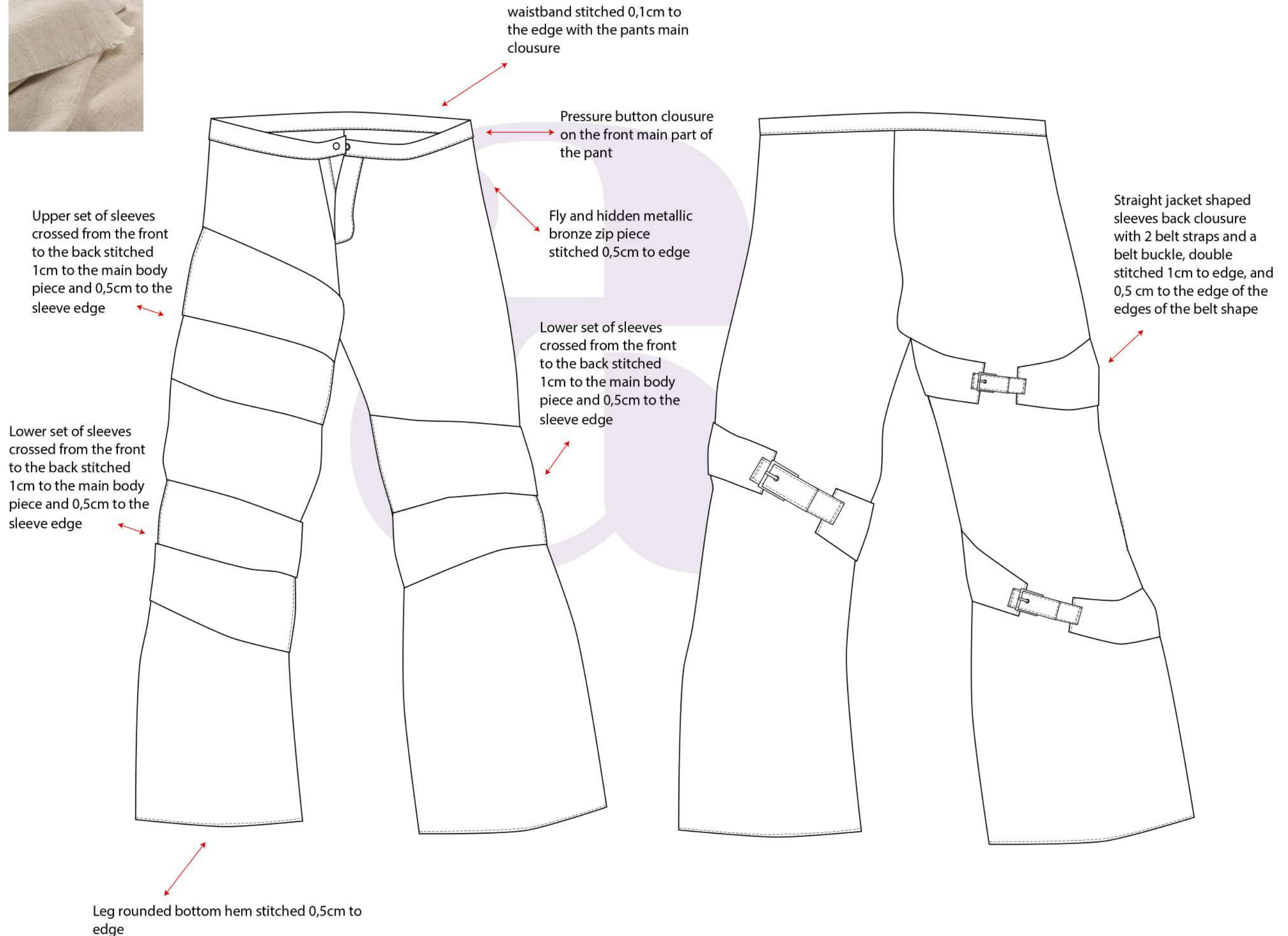

Measurements

Season	2023
Code	Final Collection
Date	21/05/2023
Supplier	UCA
Designer	Alejandro Darriba
Sample size	M

Fabric



Main Fabric:
50% Cotton, 50% Polyester
#DDD5B7

Thread positions and types

Dulux colour cotton thread
Stitched 1cm to edge on the main body
Stitched 0,5cm to edge on the legs bottom hem and the straight jacket sleeves borders
Stitched 0,1 cm to edge on the waistband

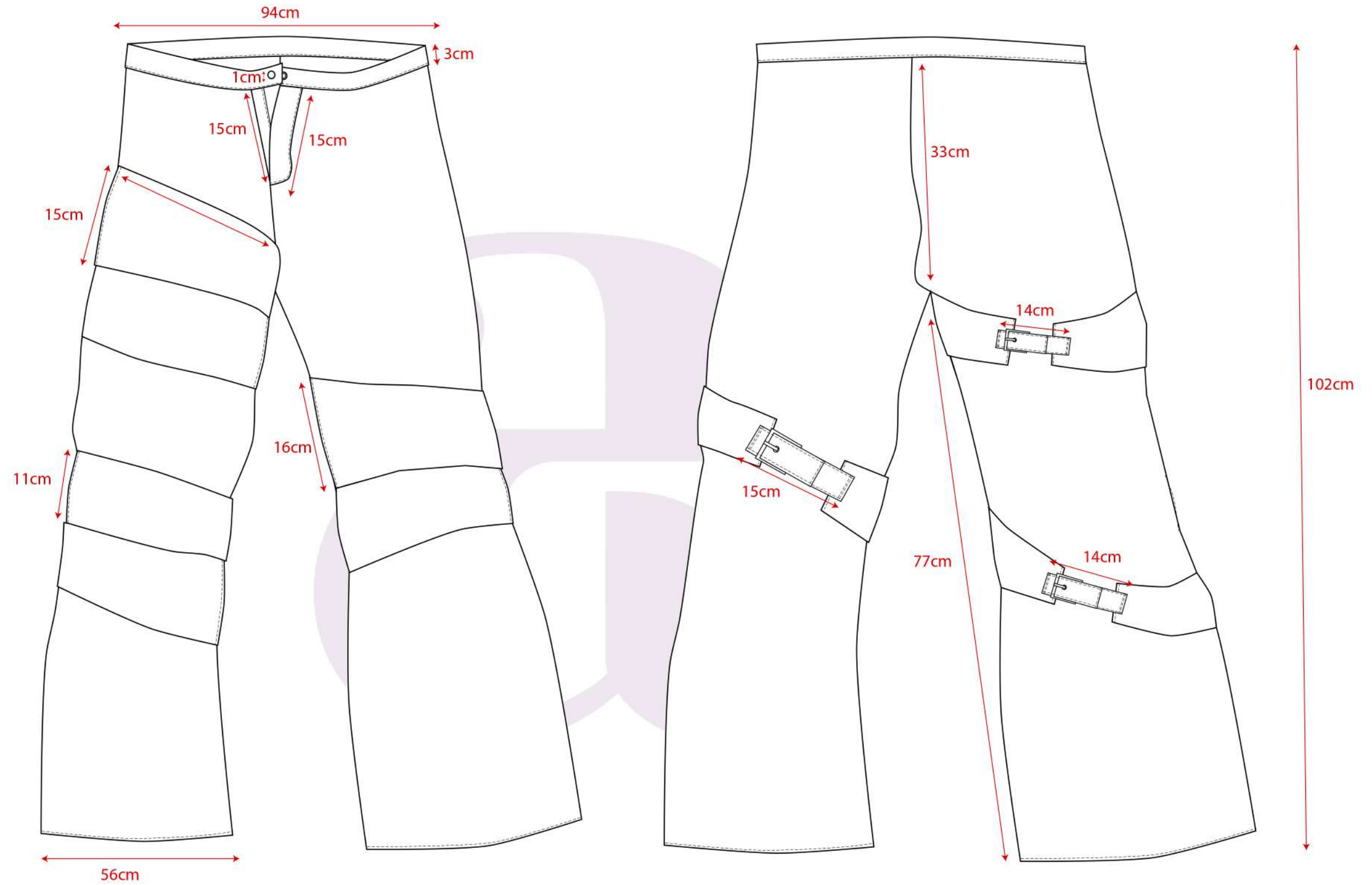

Breakdown

Details and trimmings

Season	2023
Code	Final Collection
Date	21/05/2023
Supplier	UCA
Designer	Alejandro Darriba
Sample size	M



Descriptions

waistband stitched 0,1cm to the edge with the pants main clousure

Pressure button clousure on the front main part of the pant

Fly and hidden metallic bronze zip piece stitched 0,5cm to edge

Lower set of sleeves crossed from the front to the back stitched 1cm to the main body piece and 0,5cm to the sleeve edge

Leg rounded bottom hem stitched 0,5cm to edge

Lower set of sleeves crossed from the front to the back stitched 1cm to the main body piece and 0,5cm to the sleeve edge

Upper set of sleeves crossed from the front to the back stitched 1cm to the main body piece and 0,5cm to the sleeve edge

Straight jacket shaped sleeves back clousure with 2 belt straps and a belt buckle, double stitched 1cm to edge, and 0,5 cm to the edge of the edges of the belt shape

Fabric	Placement	Colour
Linen	Main body, legs and belt straps	#DDD5B7

Trims	Placement	Colour
Metallic belt buckle	Leg belts and belt straps, and back clousures	#C0C0C0 (SILVER)
Metallic belt eyelets	Leg belts and belt straps, and back clousures	#C0C0C0 (SILVER)
Metallic zipper	Main clousure	#D4AF37 (GOLD)

Thread	Placement	Colour
100% Cottom thread	Main body, legs, belt straps and zipper	#DDD5B7

Specifications

Fabric

Cotton Twill
Very Dark desaturated orange

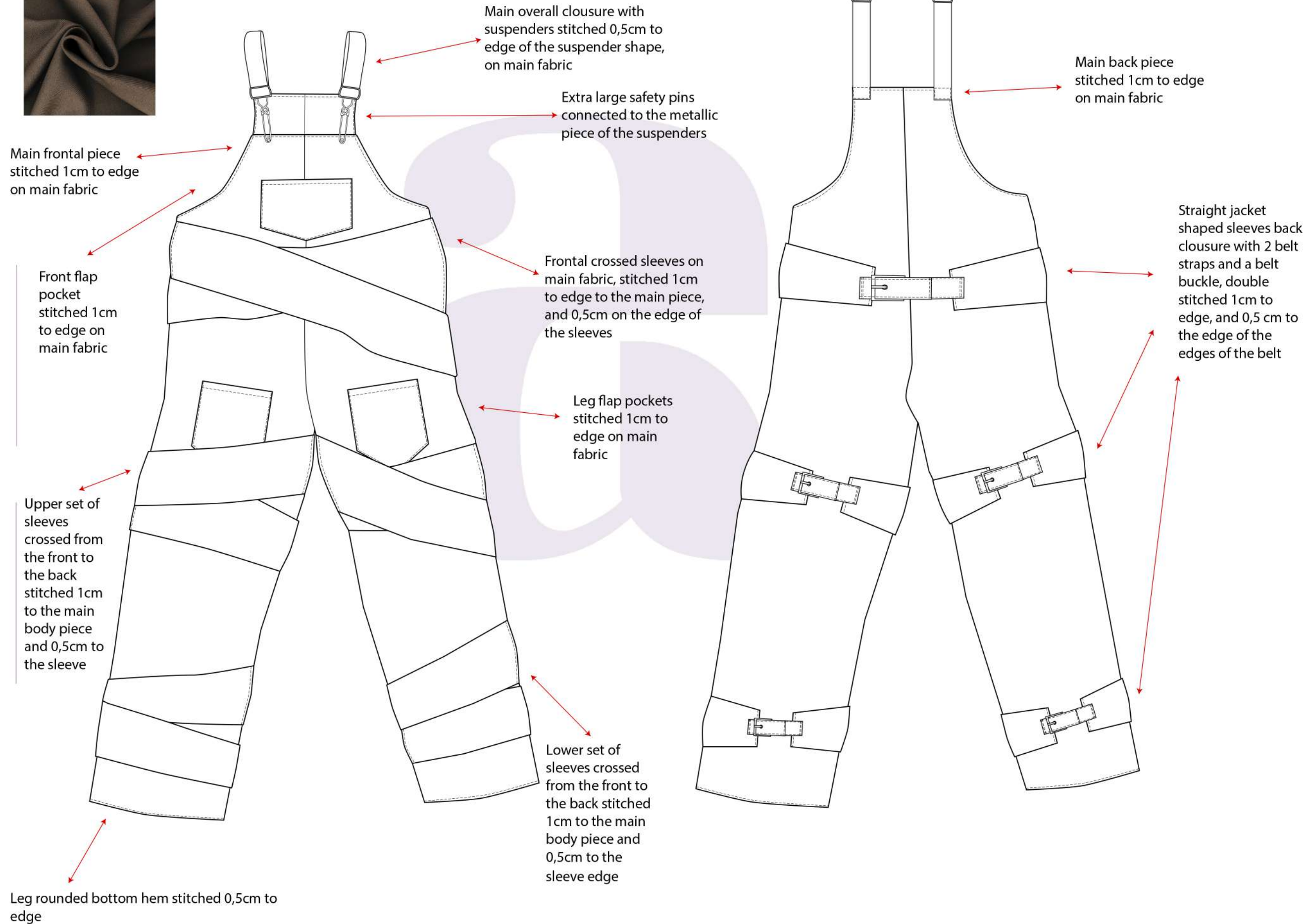

Season	2023
Code	Final Collection
Date	21/05/2023
Supplier	UCA
Designer	Alejandro Darriba
Sample size	M

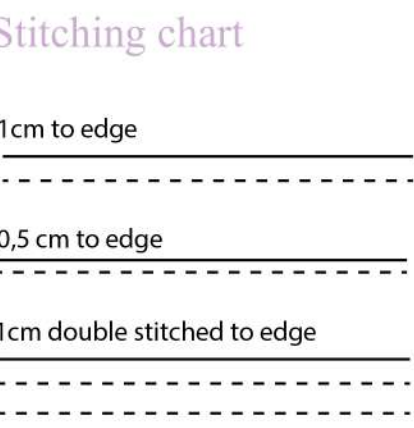

Notes

Measurements

Season	2023
Code	Final Collection
Date	21/05/2023
Supplier	UCA
Designer	Alejandro Darriba
Sample size	M

Fabric



Main Fabric:
100% cotton
#5A3825

Thread positions and types

Garnet cotton thread
Stitched 1cm to edge on the main body
Stitched 0,5cm to edge on the legs bottom hem
and the straight jacket sleeves borders
Stitched 1cm to edge on the pockets
Stitched 0,5cm to edge on the suspender straps

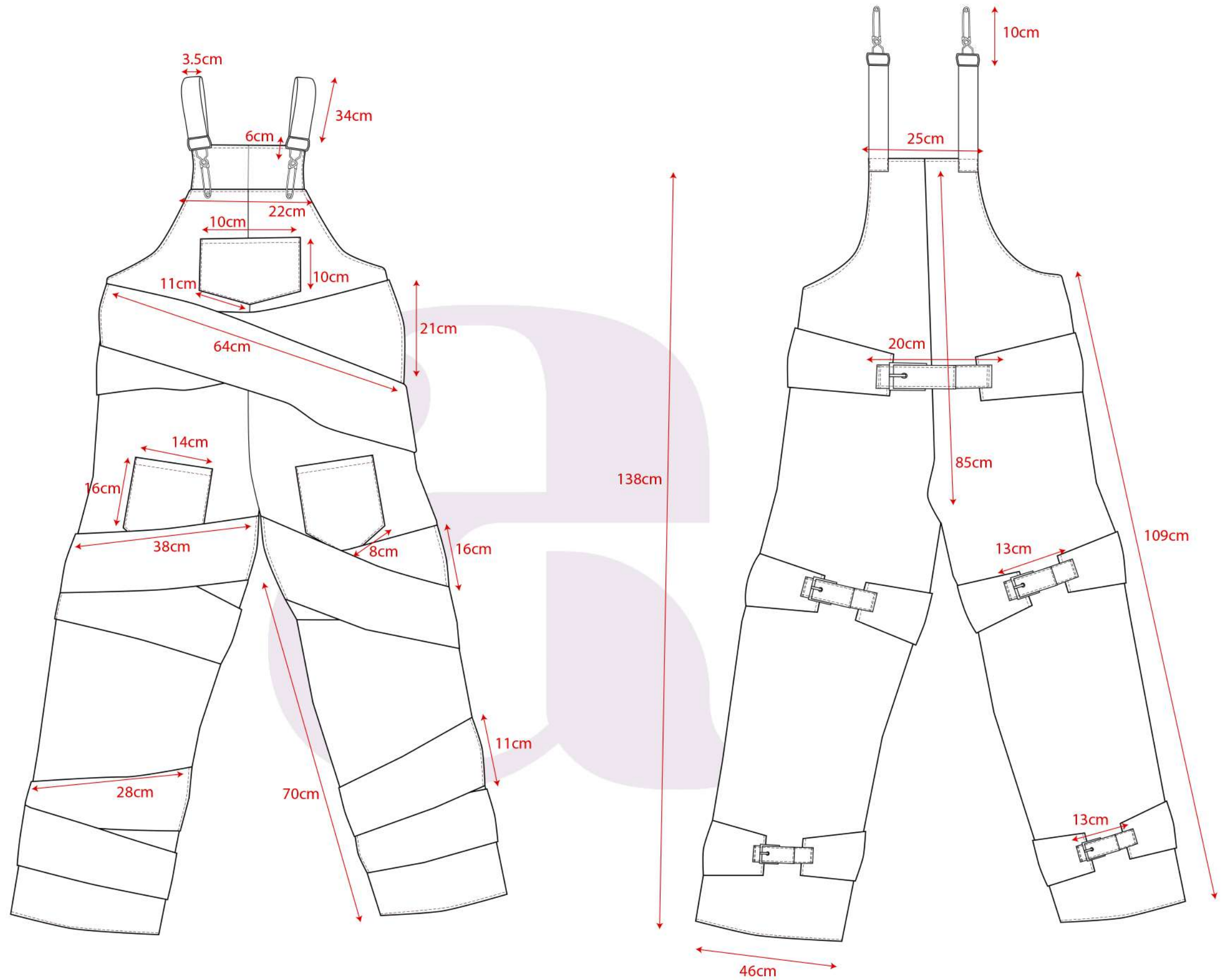

Breakdown

Details and trimmings

Season	2023
Code	Final Collection
Date	21/05/2023
Supplier	UCA
Designer	Alejandro Darriba
Sample size	M



Descriptions

Main overall clousure with suspenders stitched 0,5cm to edge of the suspender shape, on main fabric

Extra large safety pins connected to the metallic piece of the suspenders

Frontal crossed sleeves on main fabric, stitched 1cm to edge to the main piece, and 0,5cm on the edge of the sleeves

Leg flap pockets stitched 1cm to edge on main fabric

Lower set of sleeves crossed from the front to the back stitched 1cm to the main body piece and 0,5cm to the sleeve edge

Leg rounded bottom hem stitched 0,5cm to edge

Upper set of sleeves crossed from the front to the back stitched 1cm to the main body piece and 0,5cm to the sleeve

Front flap pocket stitched 1cm to edge on main fabric

Main frontal piece stitched 1cm to edge on main fabric

Main back piece stitched 1cm to edge on main fabric

Straight jacket shaped sleeves back clousure with 2 belt straps and a belt buckle, double stitched 1cm to edge, and 0,5 cm to the edge of the edges of the belt

Fabric	Placement	Colour
Cotton Twill	Main body, legs, belt and suspender straps	#5A3825

Trims	Placement	Colour
Metallic belt buckle	Leg belts and belt straps, and back clousures	#C0C0C0 (SILVER)
Metallic belt eyelets	Leg belts and belt straps, and back clousures	#C0C0C0 (SILVER)
Metallic suspender clousure	Belt suspender clousure	#C0C0C0 (SILVER)
Metallic safety pin	Belt suspender clousure	#C0C0C0 (SILVER)

Thread	Placement	Colour
100% Cottom thread	Main body, legs, belt and suspender straps	#5A3825

Specifications

Fabric

Cotton knit
#000000



Season	2023
Code	Final Collection
Date	21/05/2023
Supplier	UCA
Designer	Alejandro Darriba
Sample size	M

Stitching chart

1cm to edge



Notes

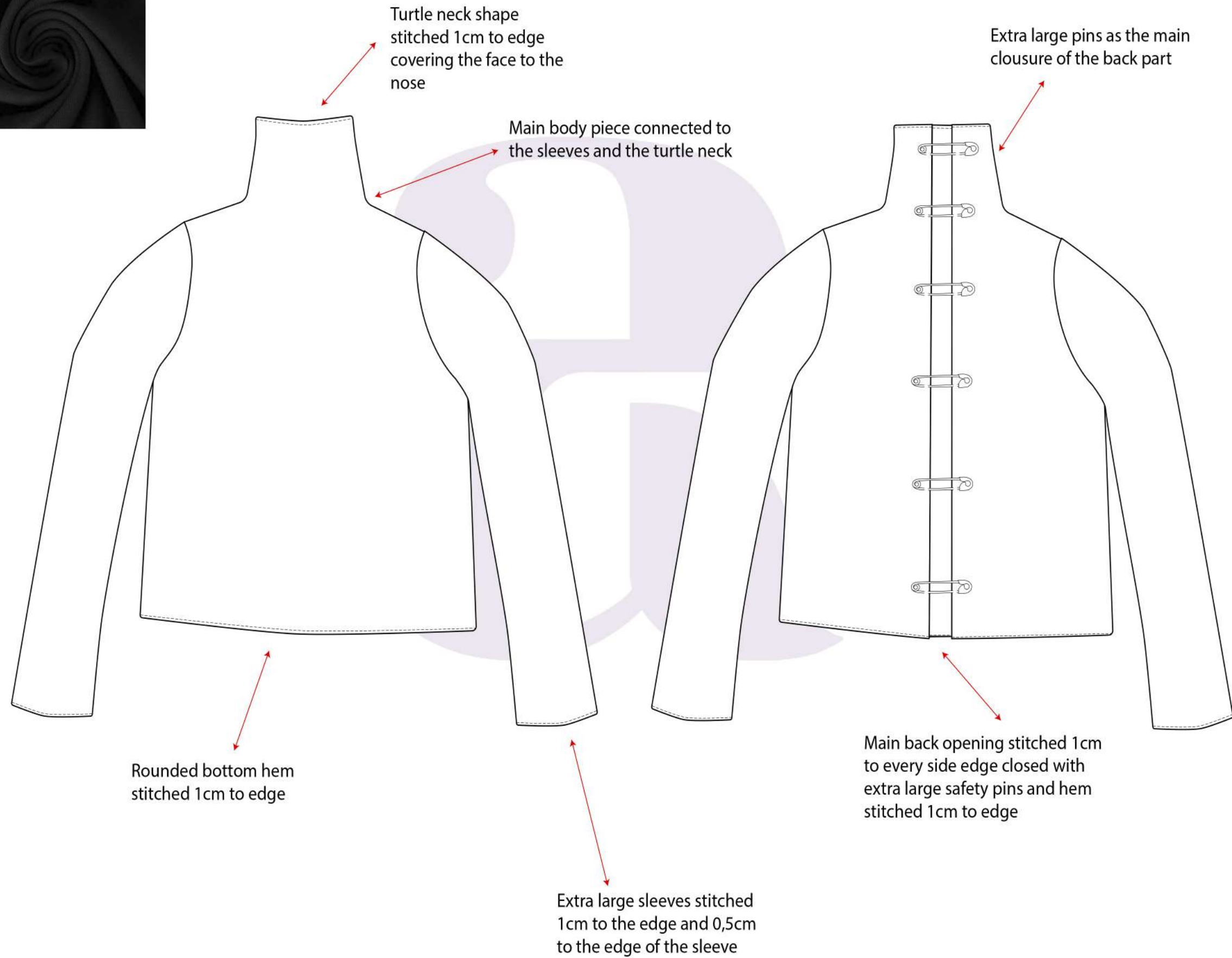

Measurements

Season	2023
Code	Final Collection
Date	21/05/2023
Supplier	UCA
Designer	Alejandro Darriba
Sample size	M

Fabric



Main Fabric:
100% cotton
#000000

Thread positions and types

Black cotton thread
Stitched 1cm to edge on the main body and sleeves

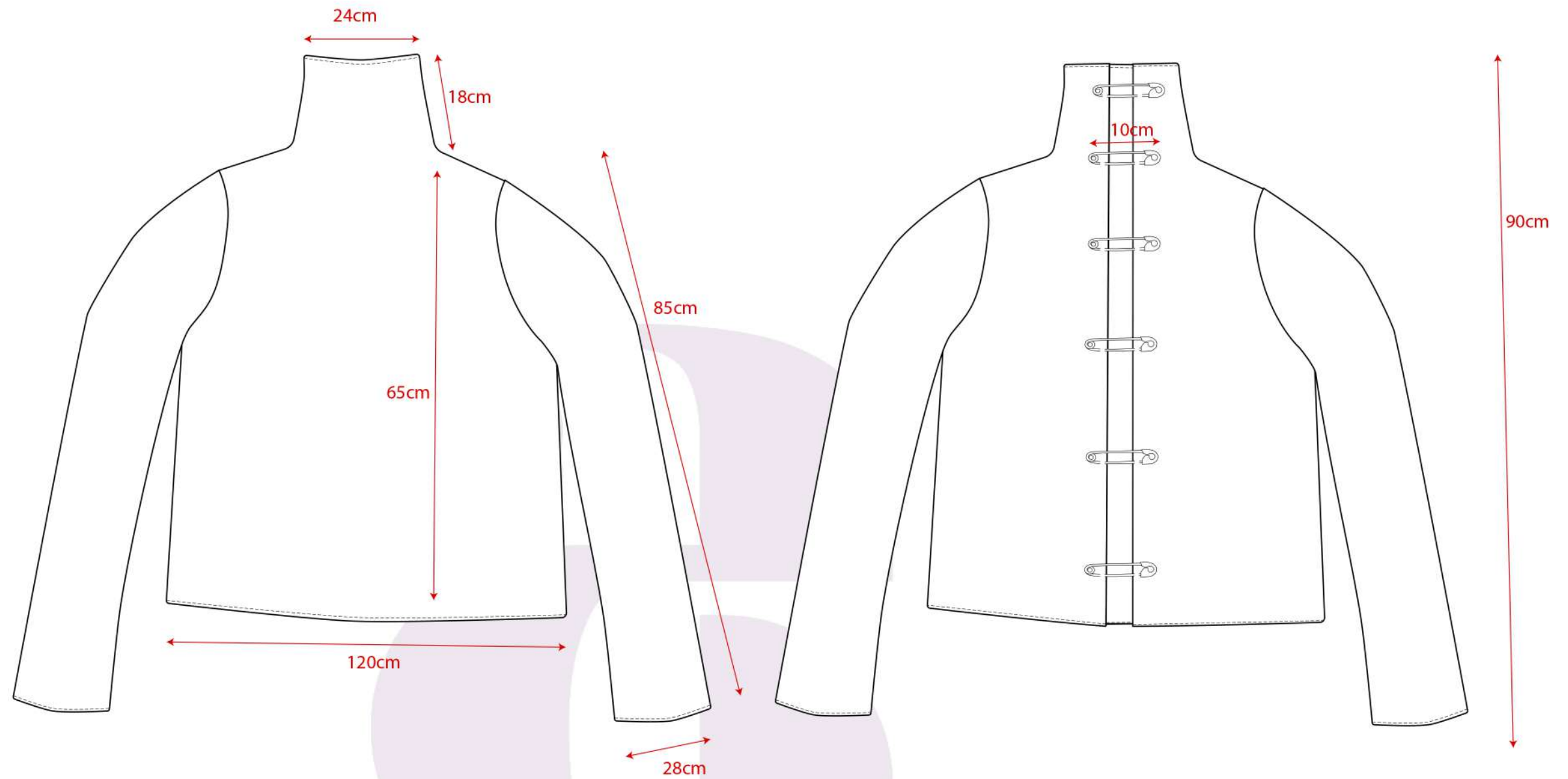

Breakdown

Details and trimmings

Season	2023
Code	Final Collection
Date	21/05/2023
Supplier	UCA
Designer	Alejandro Darriba
Sample size	M

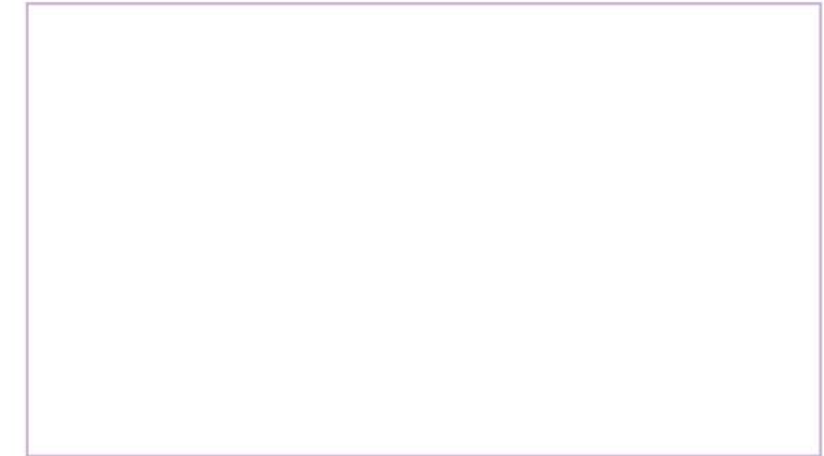
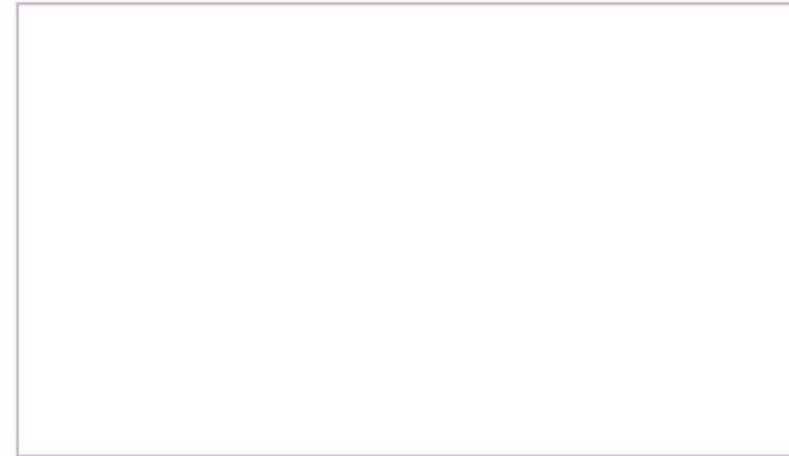

Descriptions

Turtle neck shape stitched 1cm to edge covering the face to the nose

Main body piece connected to the sleeves and the turtle neck

Rounded bottom hem stitched 1cm to edge

Extra large sleeves stitched 1cm to the edge and 0,5cm to the edge of the sleeve

Main back opening stitched 1cm to every side edge closed with extra large safety pins and hem stitched 1cm to edge

Extra large pins as the main clousure of the back part

Fabric	Placement	Colour
Cotton Knit	Main garment	#000000

Trims	Placement	Colour
Metallic safety pin	Main back clousure	#C0C0C0 (SILVER)

Thread	Placement	Colour
100% Cottom thread	Main garment	#000000

Specifications

Fabric

Season	2023
Code	Final Collection
Date	21/05/2023
Supplier	UCA
Designer	Alejandro Darriba
Sample size	M

Cotton Twill
Black



Polyester Lining
Black



Stitching chart

1cm to edge

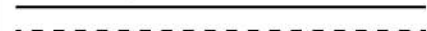

0,5 cm to edge



Notes

The coat lining pieces are stitched 1cm to edge, and reversibly stitched to the main fabric piece.

The grey part is the lining and the white part is the main fabric

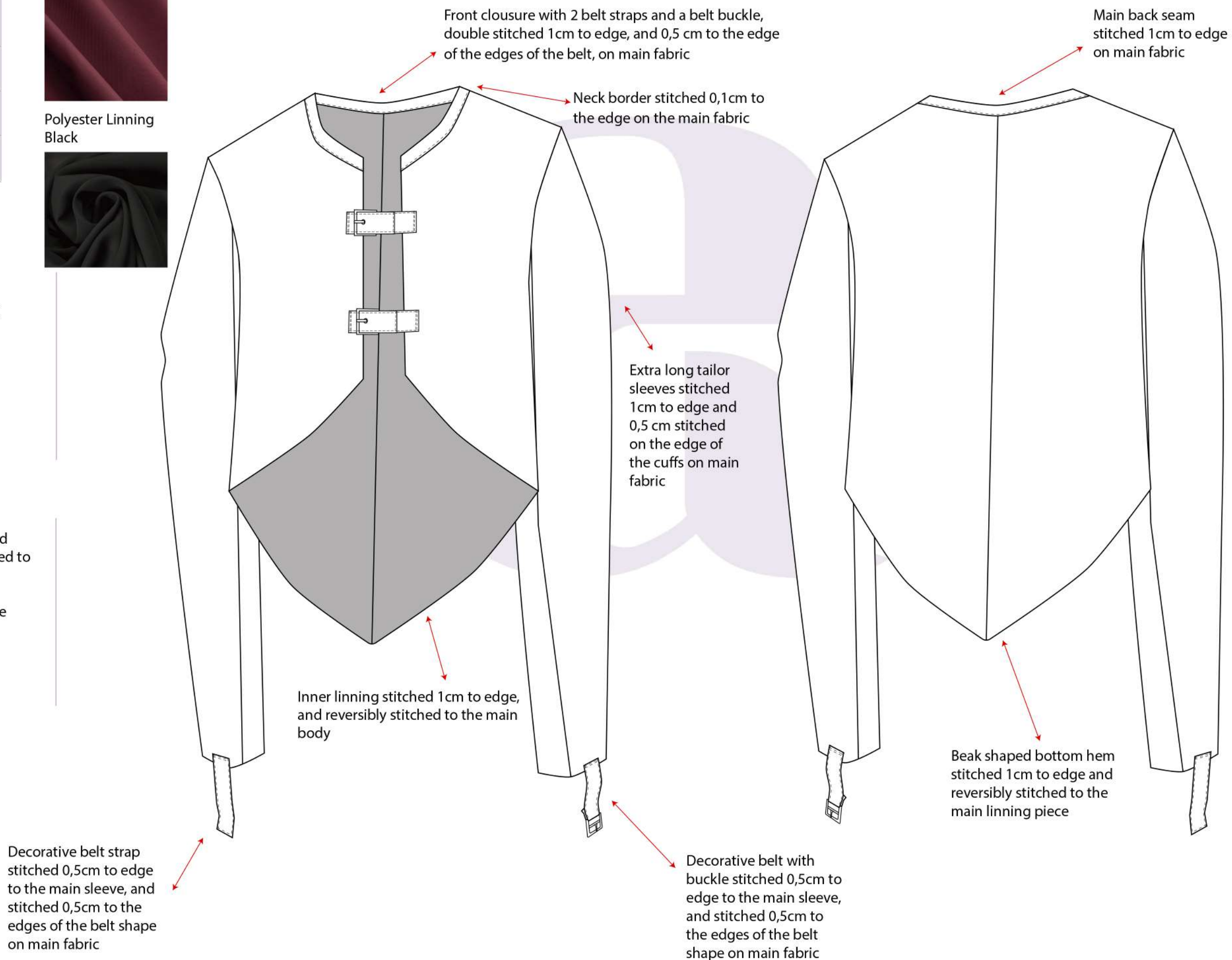

Measurements

Season	2023
Code	Final Collection
Date	21/05/2023
Supplier	UCA
Designer	Alejandro Darriba
Sample size	M

Fabric



Main fabric :
100% cotton
#781C2E



Lining:
100% Polyester
#000000

Thread positions and types

Garnet cotton thread
Stitched 1cm to edge on the main body
Stitched 0,5cm to edge on the sleeve cuffs

Black cotton thread
Stitched 1cm to edge on the lining pieces

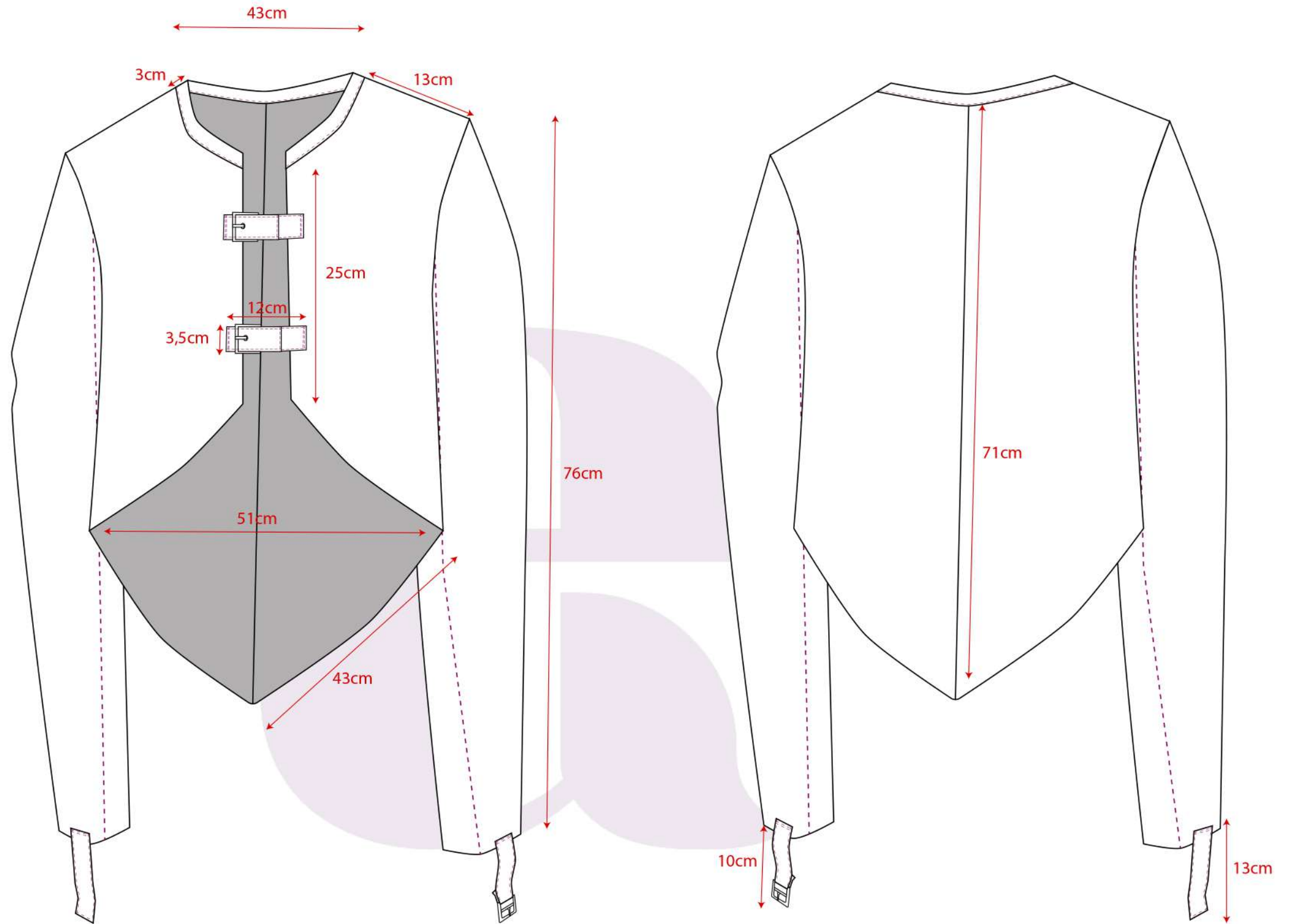

Breakdown

Details and trimmings

Season	2023
Code	Final Collection
Date	21/05/2023
Supplier	UCA
Designer	Alejandro Darriba
Sample size	M

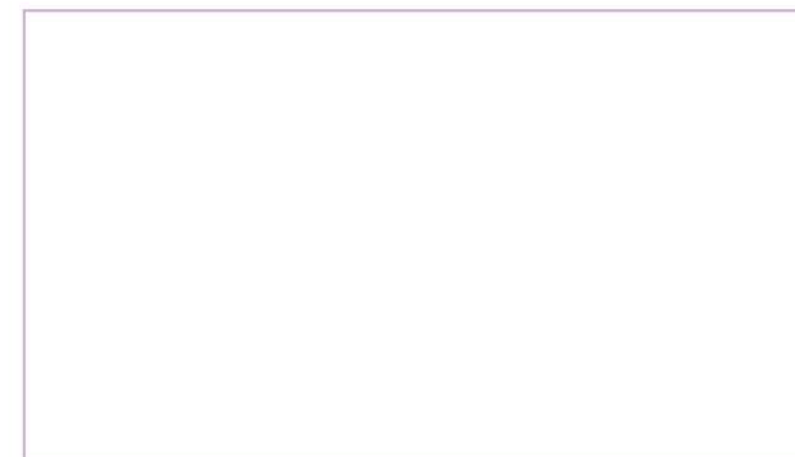

Descriptions

Front closure with 2 belt straps and a belt buckle, double stitched 1cm to edge, and 0,5 cm to the edge of the edges of the belt, on main fabric

Extra long tailor sleeves stitched 1cm to edge and 0,5 cm stitched on the edge of the cuffs on main fabric

Inner lining stitched 1cm to edge, and reversibly stitched to the main body

Decorative belt strap stitched 0,5cm to edge to the main sleeve, and stitched 0,5cm to the edges of the belt shape on main fabric

Decorative belt with buckle stitched 0,5cm to edge to the main sleeve, and stitched 0,5cm to the edges of the belt shape on main fabric

Beak shaped bottom hem stitched 1cm to edge and reversibly stitched to the main lining piece

Main back seam stitched 1cm to edge on main fabric

Fabric	Placement	Colour
Cotton Twill	Main fabric, sleeves and neck border	#781C2E
Polyester lining	Main lining and sleeves lining	#000000

Trims	Placement	Colour
Metallic belt buckle	Sleeve belts and belt straps	#C0C0C0 (SILVER)
Metallic belt eyelets	Sleeve belts and belt straps	#C0C0C0 (SILVER)

Thread	Placement	Colour
Cotton thread	Main fabric, sleeves and neck border	#781C2E
Cotton thread	Main lining and sleeves lining	#000000

Specifications

Fabric

Season	2023
Code	Final Collection
Date	21/05/2023
Supplier	UCA
Designer	Alejandro Darriba
Sample size	M

Cotton Elastic Knit
Black



Polyester Elastic Knit
White



Stitching chart

1cm to edge



Notes

Raw finished edges and irregularities on the dress stripes are done on purpose to portrait one of the concepts of the dress

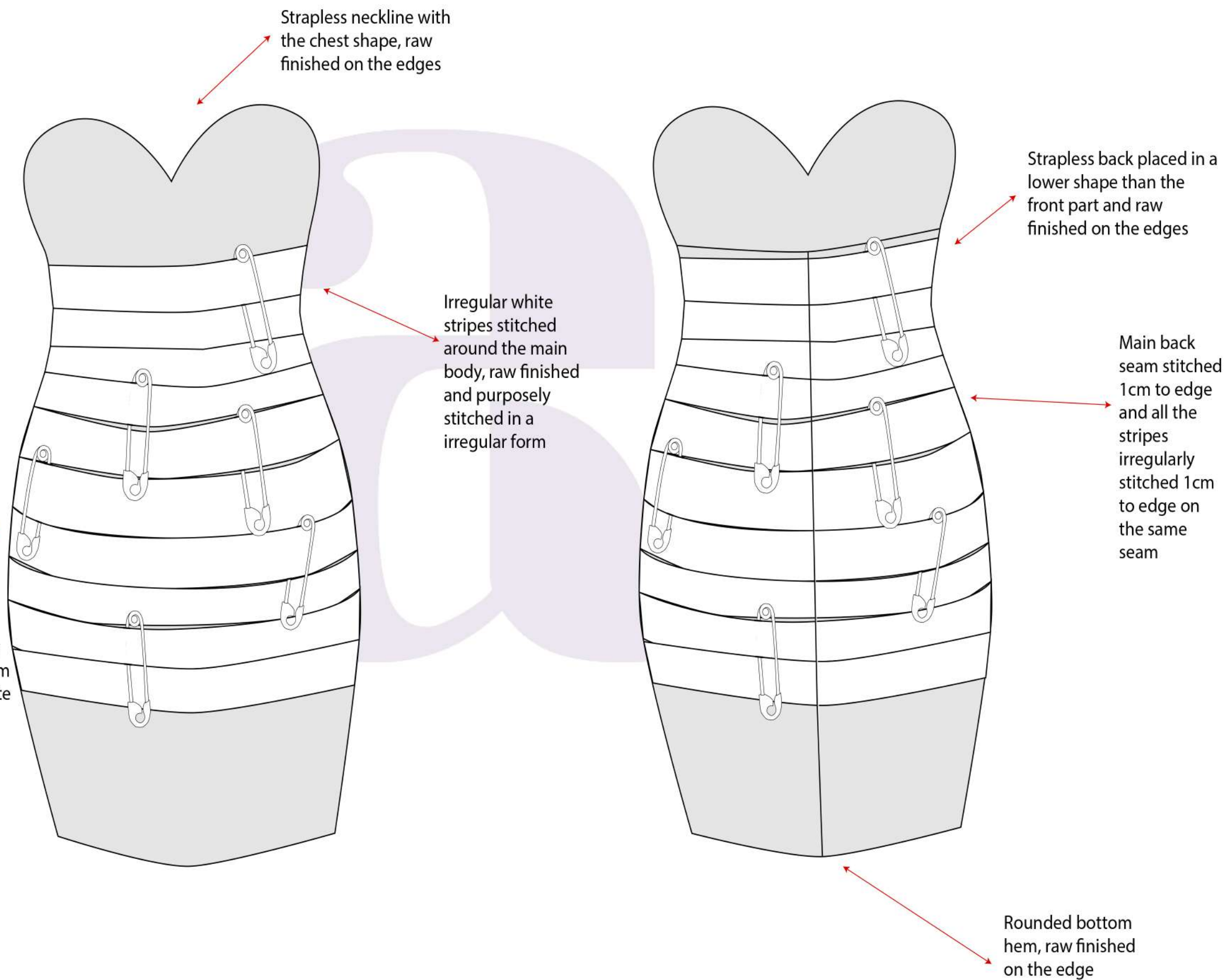

Measurements

Season	2023
Code	Final Collection
Date	21/05/2023
Supplier	UCA
Designer	Alejandro Darriba
Sample size	M

Fabric



Main Fabric:
100% cotton
#000000



Secondary Fabric:
100% polyester
#FFFFFF

Thread positions and types

Black cotton thread
Main back seam



White elastic thread
Main back seam and stripes seams to the back seam
Raw stitch on the stripes

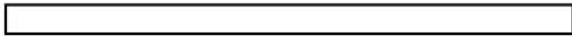

White cotton thread
Main back seam and stripes seams to the back seam
Raw stitch on the stripes

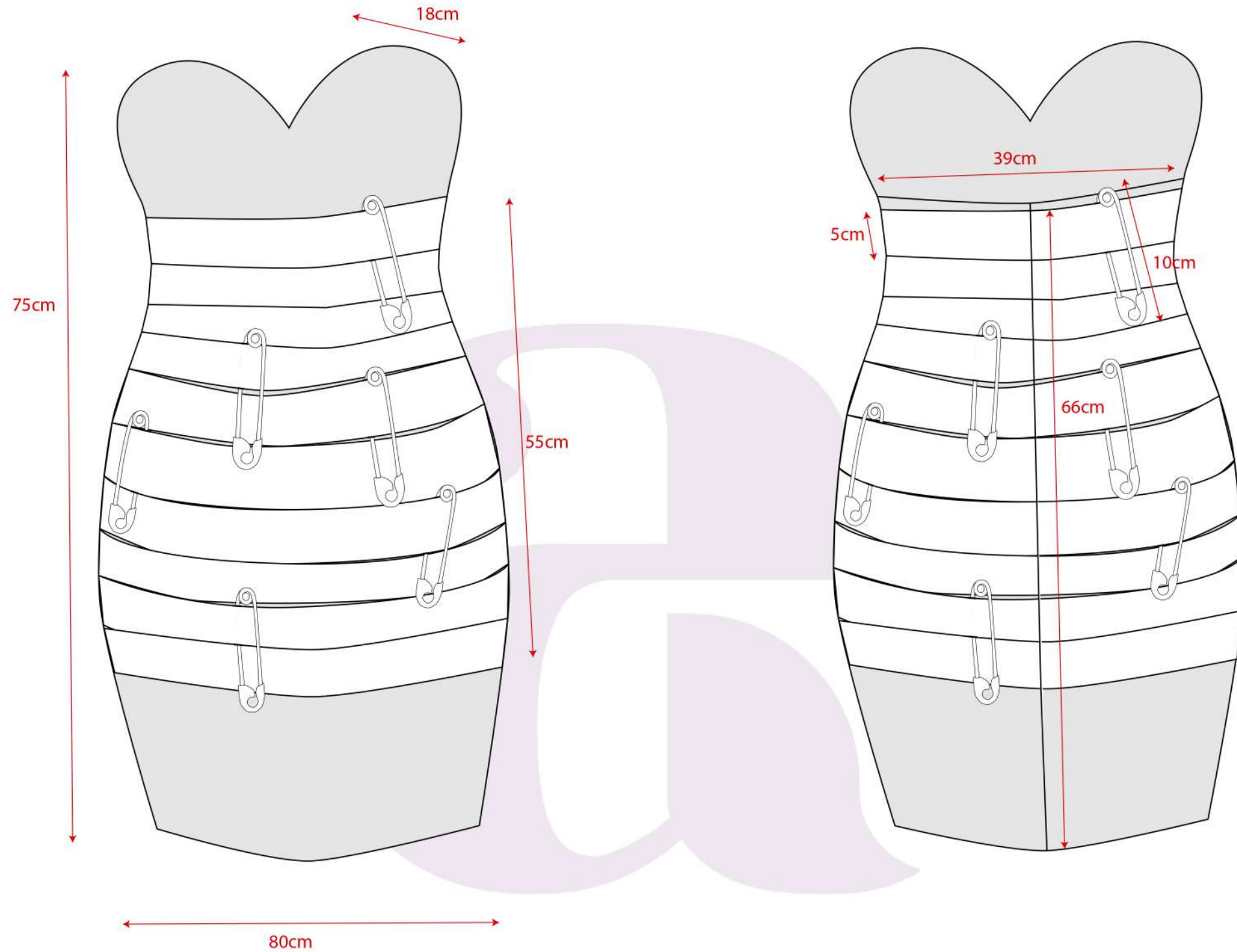

Breakdown

Details and trimmings

Season	2023
Code	Final Collection
Date	21/05/2023
Supplier	UCA
Designer	Alejandro Darriba
Sample size	M

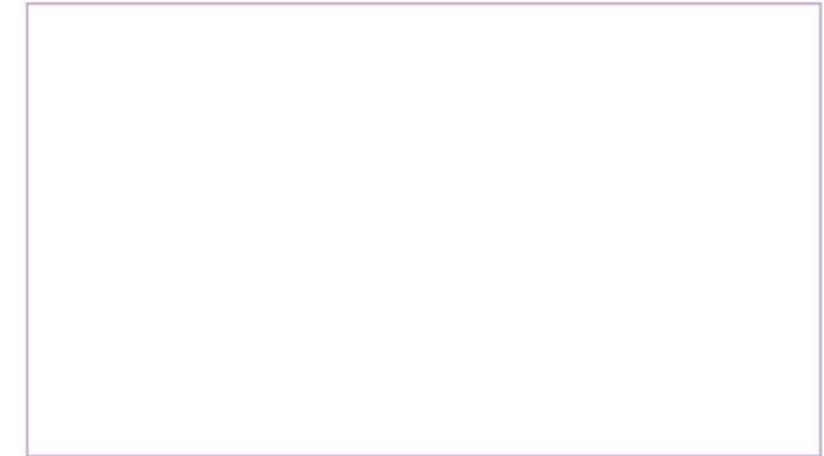
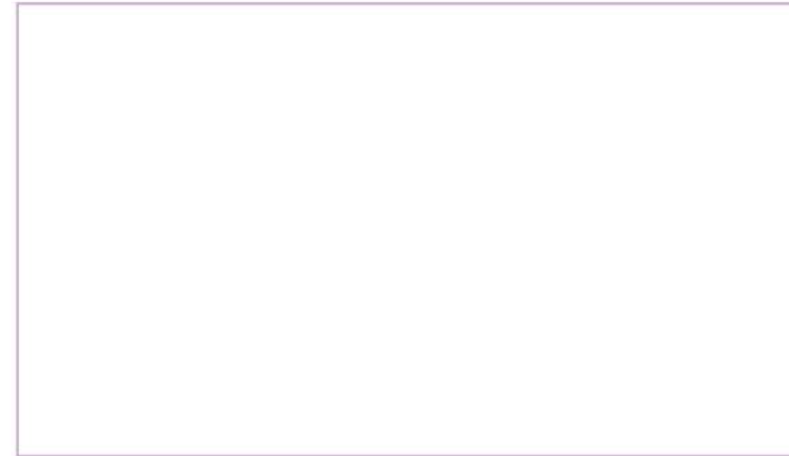

Descriptions

Strapless neckline with the chest shape, raw finished on the edges

Irregular white stripes stitched around the main body, raw finished and purposely stitched in a irregular form

Extra large safety pins hanging from the irregular white stripes

Strapless back placed in a lower shape than the front part and raw finished on the edges

Main back seam stitched 1cm to edge and all the stripes irregularly stitched 1cm to edge on the same seam

Rounded bottom hem, raw finished on the edge

Fabric	Placement	Colour
Cotton Elastic knit	Main body	#000000
Polyester Elastic knit	Body Stripes	#FFFFFF

Trims	Placement	Colour
Metallic safety pin	Hanging from the main body stripes	#C0C0C0 (SILVER)

Thread	Placement	Colour
100% Cotton thread	Main body and stripes	#000000 and #FFFFFF
100% Elastic thread	Main body and stripes	#FFFFFF

Specifications

Fabric

Season	2023
Code	Final Collection
Date	21/05/2023
Supplier	UCA
Designer	Alejandro Darriba
Sample size	M

Waterproof Fabric
Yellow



Polyester Lining
Black

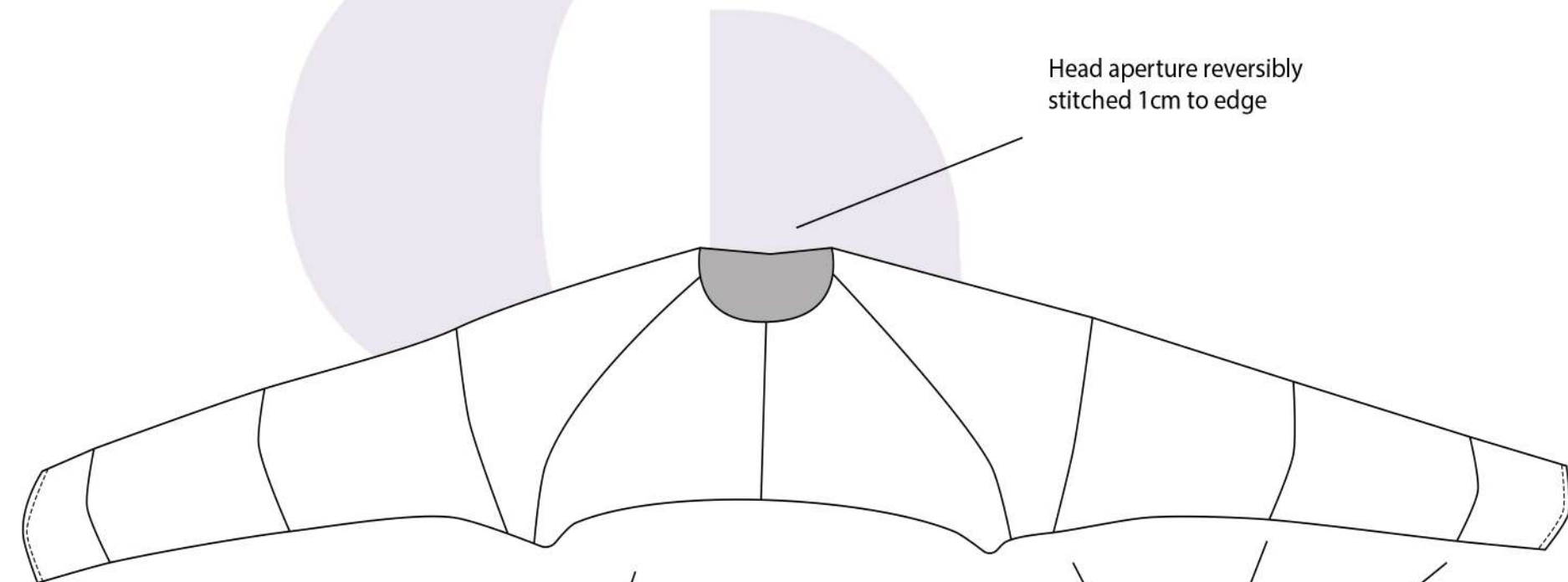
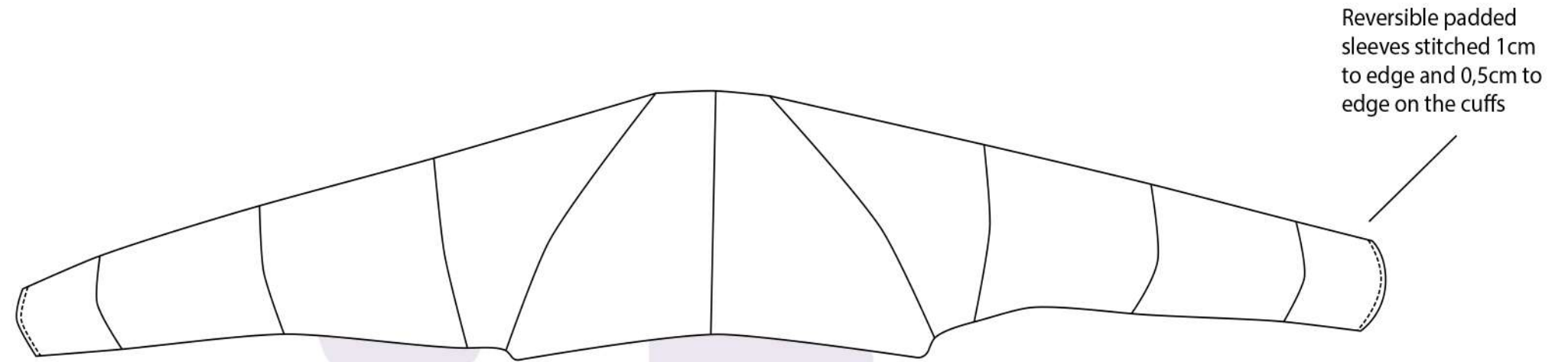

Stitching chart

1cm to edge

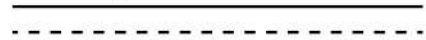

0,5 cm to edge

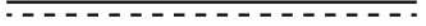

Notes

The coat lining pieces are stitched 1cm to edge, and reversibly stitched to the main fabric piece.

The grey part is the lining and the white part is the main fabric

Lower body aperture with a curved shaped bottom hem reversibly stitched 1cm to the edge

Padded sleeves curved decorated seams stitched on top of the main fabric

Measurements

Season	2023
Code	Final Collection
Date	21/05/2023
Supplier	UCA
Designer	Alejandro Darriba
Sample size	M

Fabric



Main Fabric:
100% Polyester
#FFD700



Lining:
100% Polyester
#000000

Thread positions and types

Yellow cotton thread
Stitched 1cm to edge on the main body
Stitched 0,5cm to edge on the sleeve cuffs

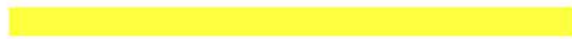

Black cotton thread
Stitched 1cm to edge on the lining pieces

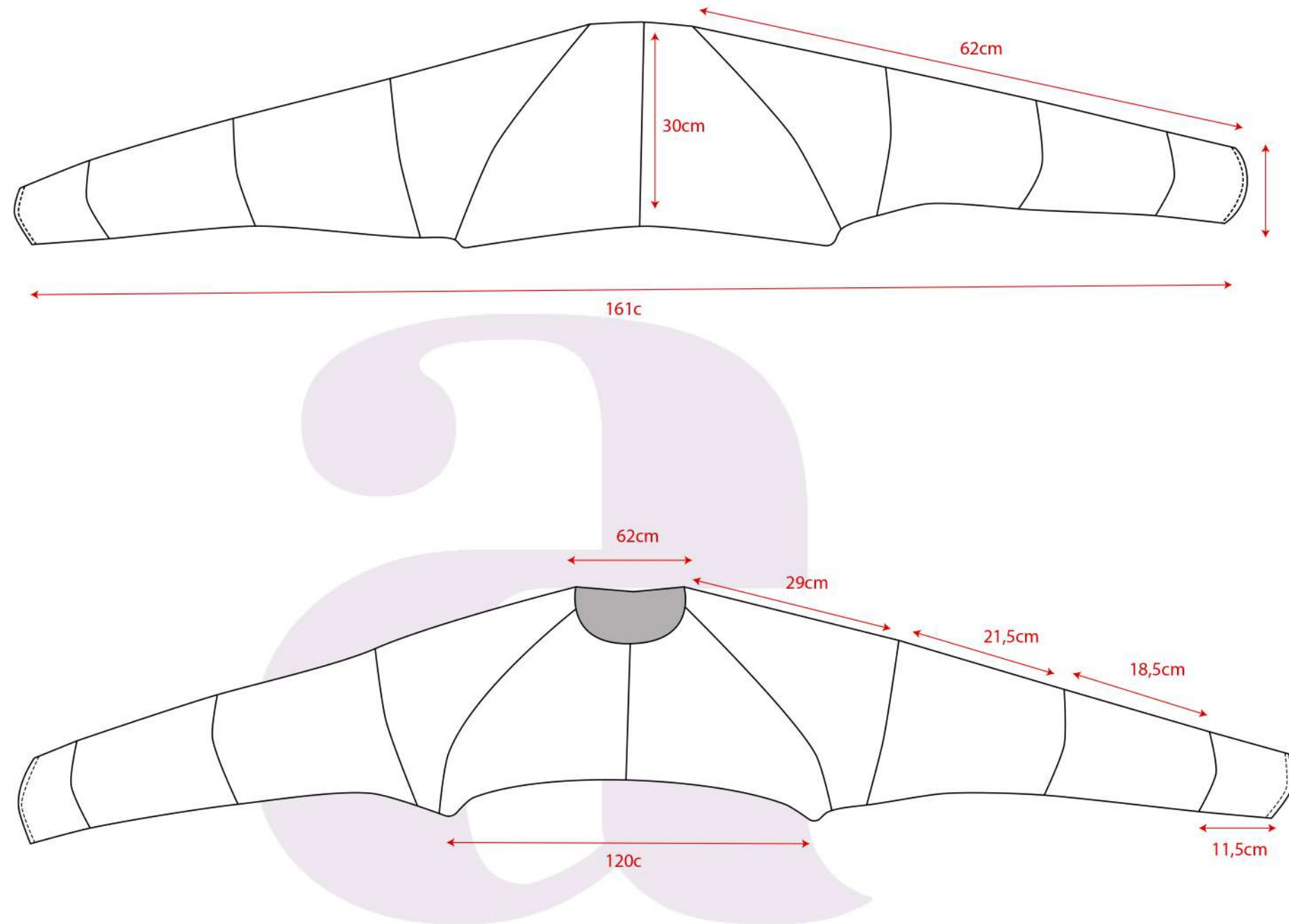

Breakdown

Details and trimmings

Season	2023
Code	Final Collection
Date	21/05/2023
Supplier	UCA
Designer	Alejandro Darriba
Sample size	M

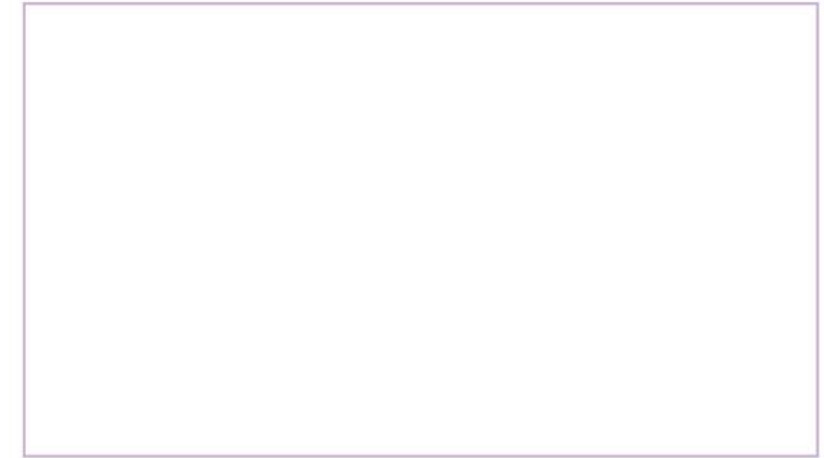
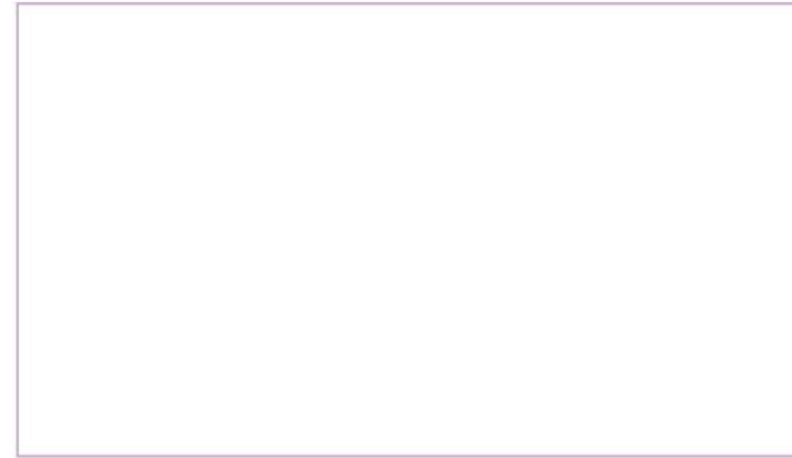
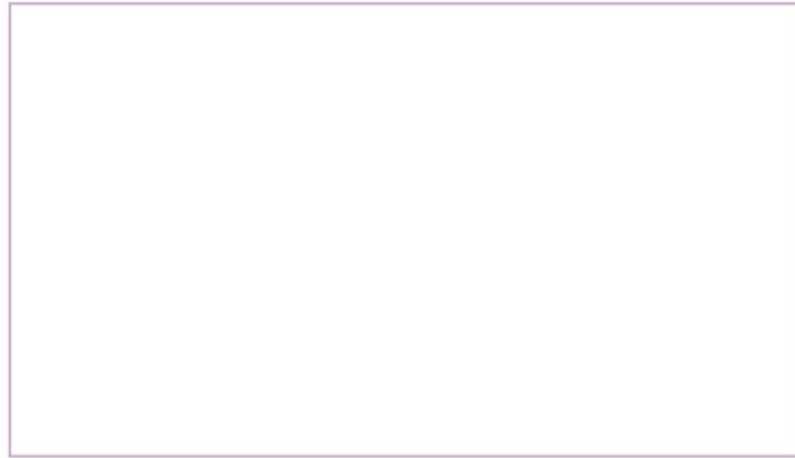

Descriptions

Reversible padded sleeves stitched 1cm to edge and 0,5cm to edge on the cuffs

Head aperture reversibly stitched 1cm to edge

Lower body aperture with a curved shaped bottom hem reversibly stitched 1cm to the edge

Padded sleeves curved decorated seams stitched on top of the main fabric

Fabric	Placement	Colour
Waterproof	Main body and sleeves	#FFD700
Polyester lining	Main lining and sleeves lining	#000000

Trims	Placement	Colour

Thread	Placement	Colour
Cotton thread	Main body and sleeves	#FFD700
Cotton thread	Main lining and sleeves lining	#000000

Specifications

Fabric

Season	2023
Code	Final Collection
Date	21/05/2023
Supplier	UCA
Designer	Alejandro Darriba
Sample size	M

Cotton Pique
White



Cotton Twill
White



Shiny Polyester lining
White



Stitching chart

1cm to edge



0,5 cm to edge



1cm to edge both sides (Boning)



0,1cm to edge



Notes

The coat lining pieces are stitched 1cm to edge, and stitched 0,1cm to edge on the lining borders

The grey part is the lining and the white part is the main fabric

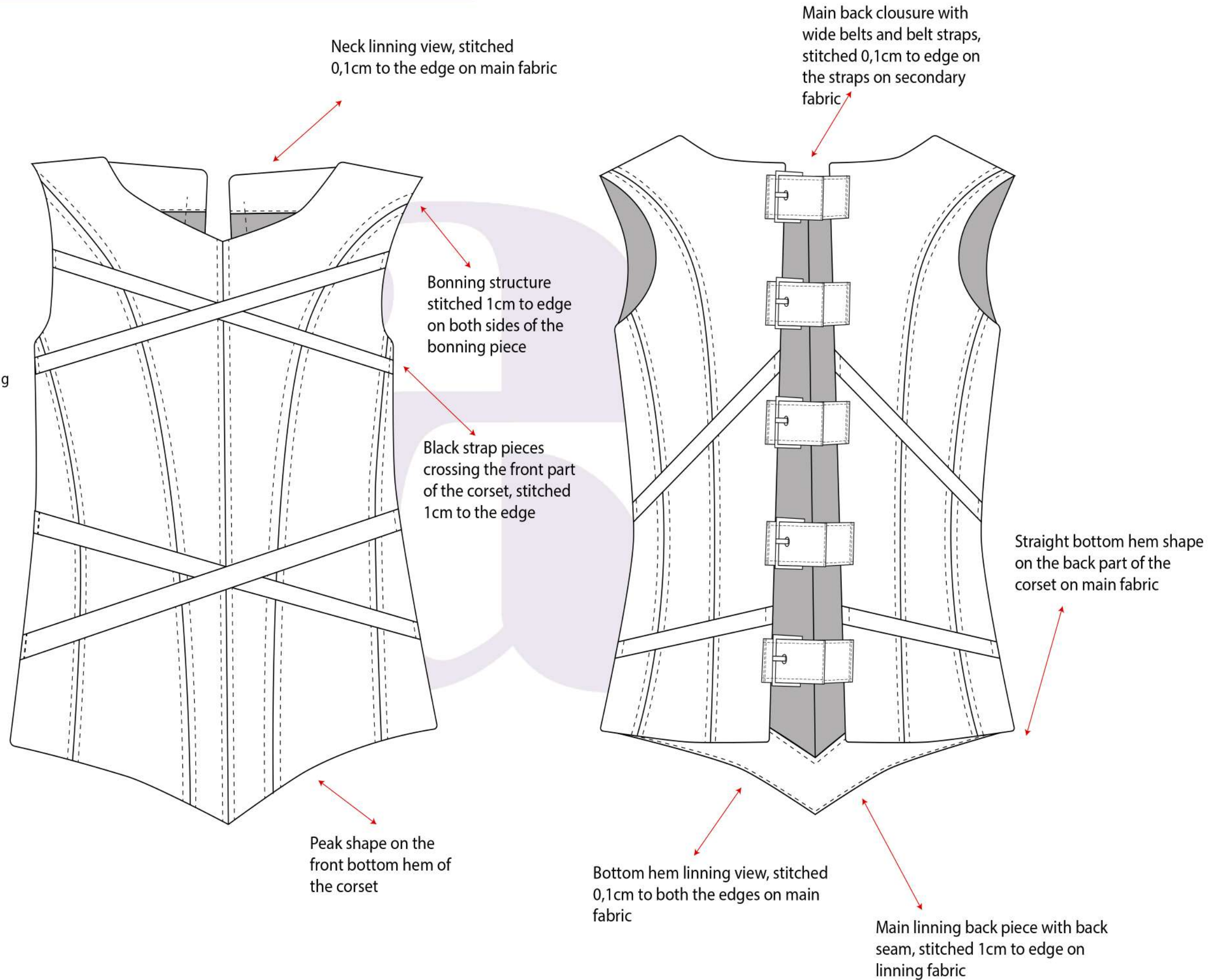

Measurements

Season	2023
Code	Final Collection
Date	21/05/2023
Supplier	UCA
Designer	Alejandro Darriba
Sample size	M

Fabric



Main Fabric:
100% cotton
#FFFFFF



Secondary Fabric:
100% cotton
#FFFFFF



Lining:
100% polyester
#FFFFFF

Thread positions and types

White cotton thread
Main Piece and lining



White cotton thread
Bonning



Black cotton thread
Straps



White cotton thread
Belt Straps

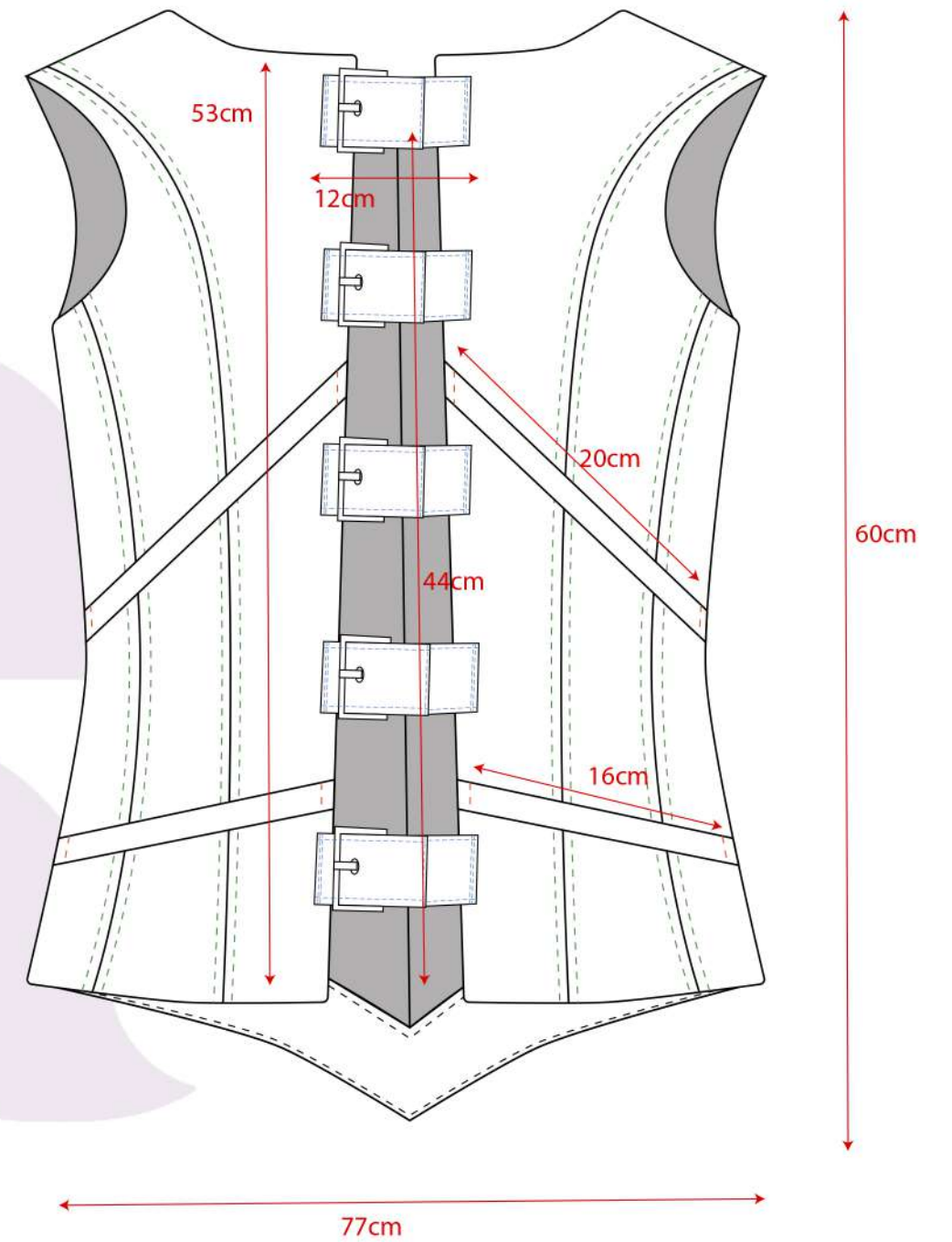
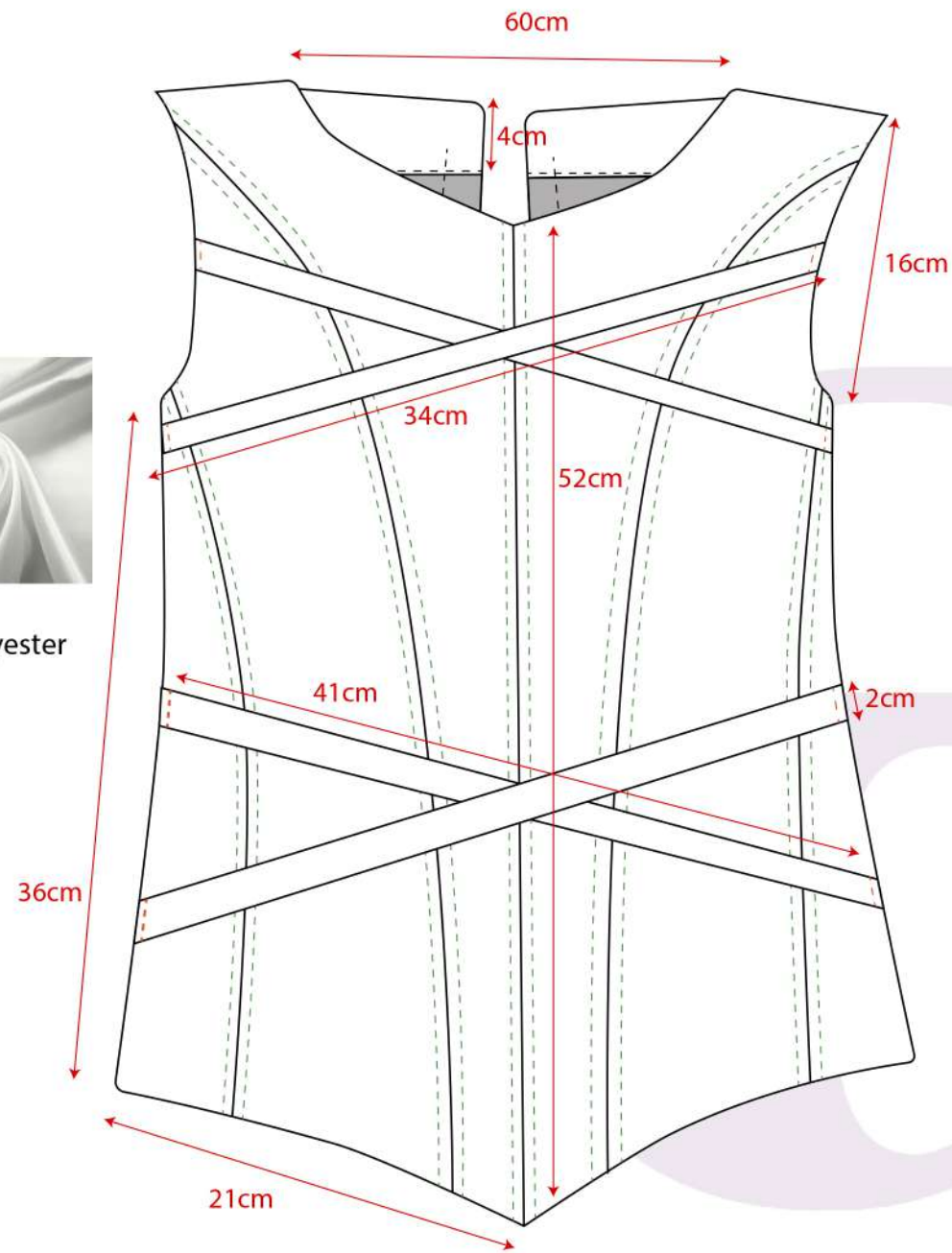

Breakdown

Details and trimmings

Season	2023
Code	Final Collection
Date	21/05/2023
Supplier	UCA
Designer	Alejandro Darriba
Sample size	M



Descriptions

- Neck lining view, stitched 0,1cm to the edge on main fabric
- Bonning structure stitched 1cm to edge on both sides of the bonning piece
- Black strap pieces crossing the front part of the corset, stitched 1cm to the edge
- Peak shape on the front bottom hem of the corset
- Bottom hem lining view, stitched 0,1cm to both the edges on main fabric
- Main lining back piece with back seam, stitched 1cm to edge on lining fabric
- Straight bottom hem shape on the back part of the corset on main fabric
- Main back clousure with wide belts and belt straps, stitched 0,1cm to edge on the straps on secondary fabric

Fabric	Placement	Colour
Cotton Pique	Main body	#FFFFFF
Cotton Twill	Belt straps	#FFFFFF
Polyester lining	Linning	#FFFFFF

Trims	Placement	Colour
Metallic belt buckle	Leg belts and belt straps, and back clousures	#C0C0C0 (SILVER)
Metallic belt eyelets	Leg belts and belt straps, and back clousures	#C0C0C0 (SILVER)

Thread	Placement	Colour
100% Cotton thread	Main body, linning, bonning and belt straps	#FFFFFF
100% Cotton thread	Corset straps	#000000

Specifications

Fabric

Cotton Twill
White



waistband stitched 0,1cm to the edge with the pants main clousure

Pressure button clousure on the front main part of the pant

Fly and hidden metallic bronze zip piece stitched 0,5cm to edge

Black strap pieces crossing the front part of the corset, stitched 1cm to the edge

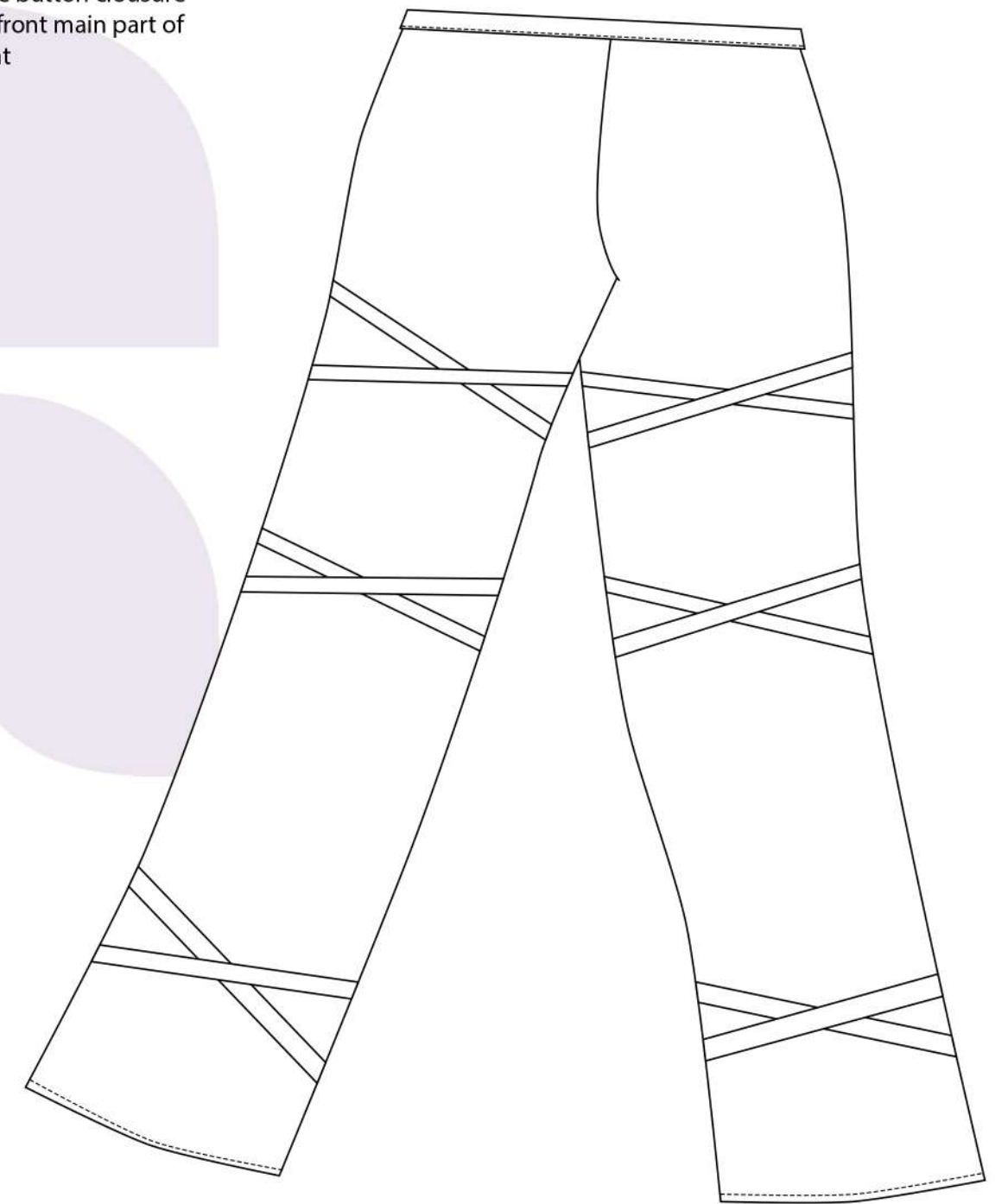
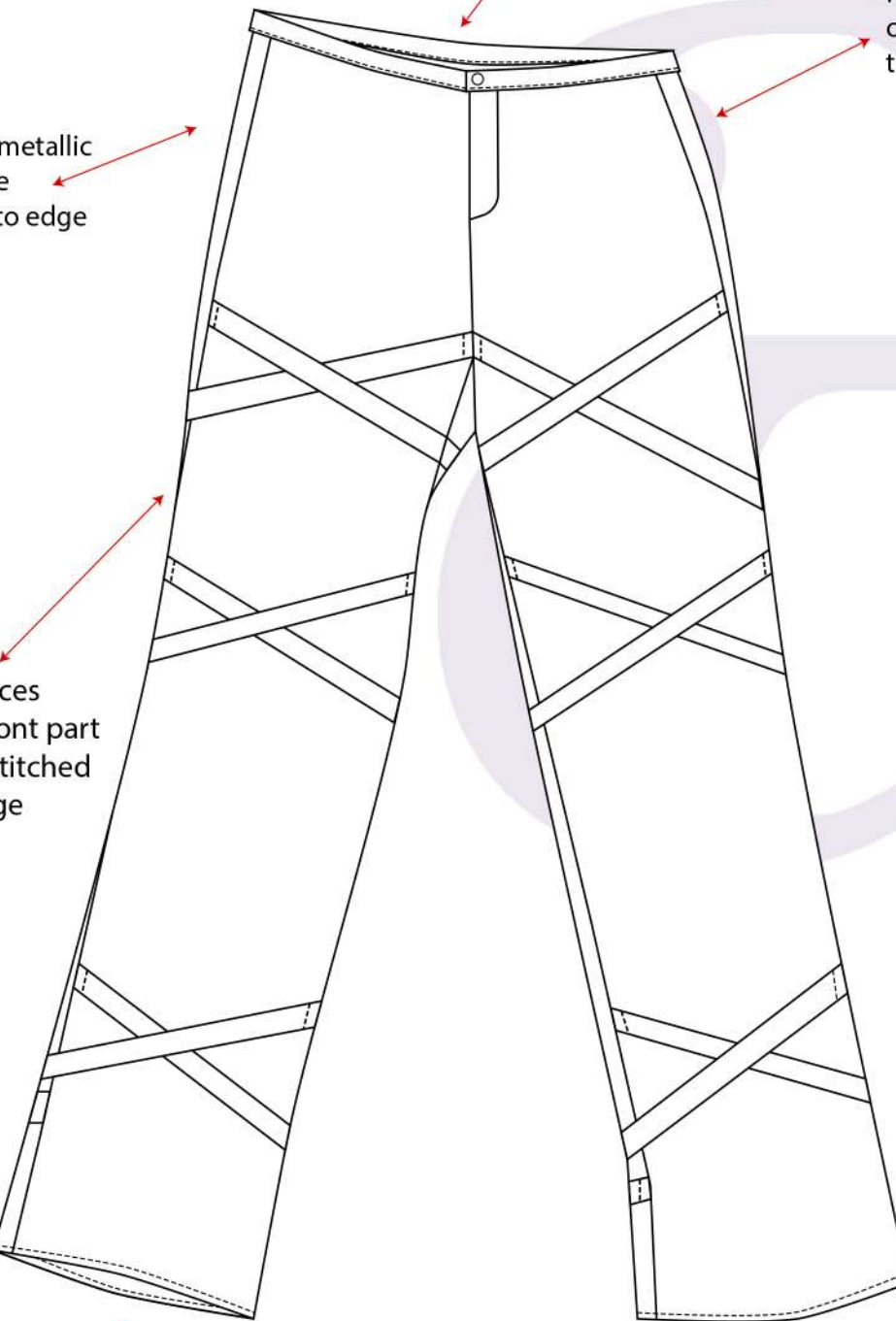

Leg rounded bottom hem stitched 0,5cm to edge

Season	2023
Code	Final Collection
Date	21/05/2023
Supplier	UCA
Designer	Alejandro Darriba
Sample size	M

Stitching chart

1cm to edge



0,5 cm to edge



Notes

All the borders of the garment are stitched 0,5cm to the inside to give the image of a raw finished

Measurements

Season	2023
Code	Final Collection
Date	21/05/2023
Supplier	UCA
Designer	Alejandro Darriba
Sample size	M

Fabric



Main Fabric:
100% cotton
#FFFFFF

Thread positions and types

White colour cotton thread
Stitched 1cm to edge on the main body
Stitched 0,5cm to edge on the legs bottom hem
Stitched 0,1 cm to edge on the waistband

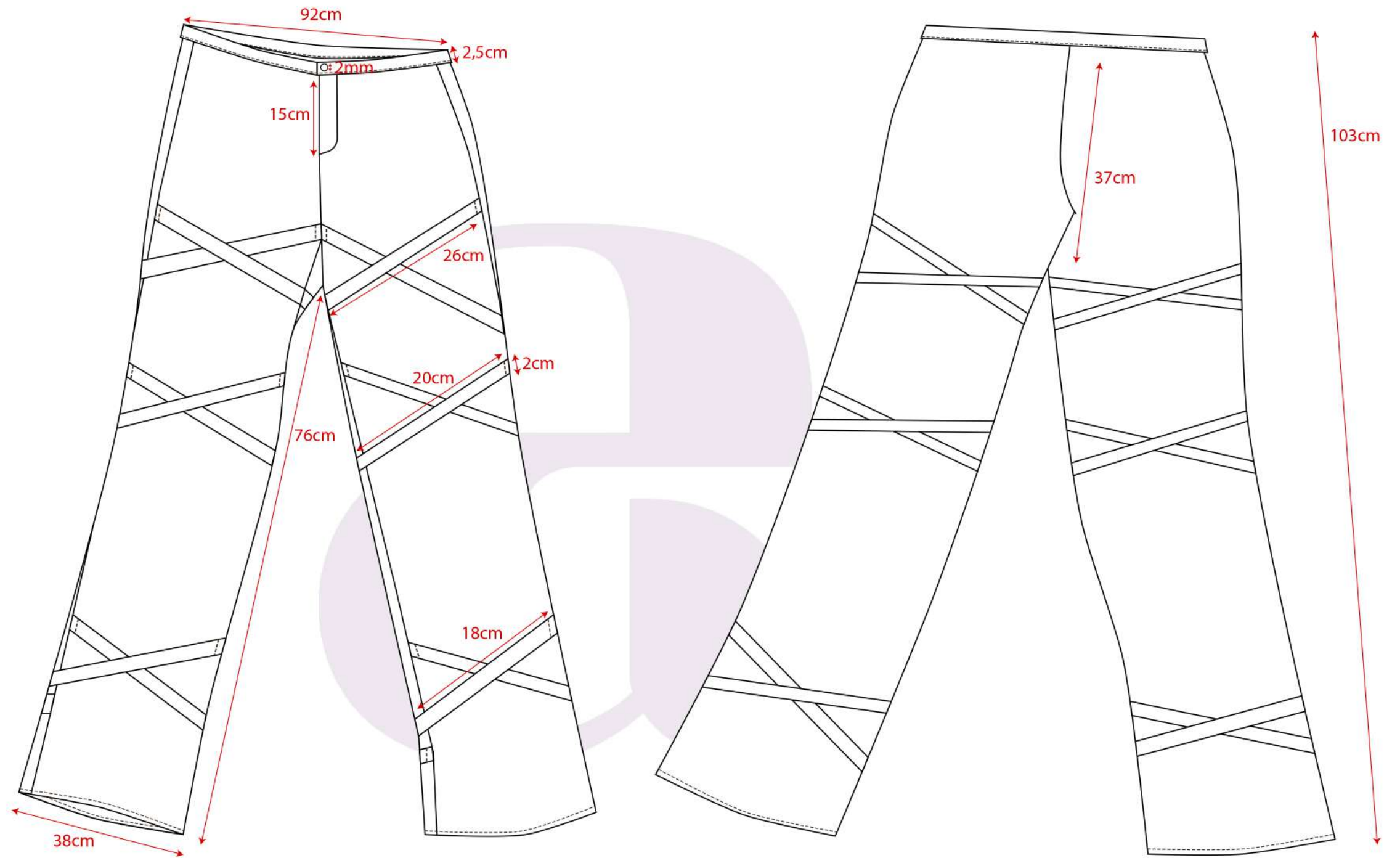

Breakdown

Details and trimmings

Season	2023
Code	Final Collection
Date	21/05/2023
Supplier	UCA
Designer	Alejandro Darriba
Sample size	M



Descriptions

waistband stitched 0,1cm to the edge with the pants main clousure

Fly and hidden metallic bronze zip piece stitched 0,5cm to edge

Black strap pieces crossing the front part of the corset, stitched 1cm to the edge

Leg rounded bottom hem stitched 0,5cm to edge

Pressure button clousure on the front main part of the pants

Fabric	Placement	Colour
Cotton Twill	Main body, legs and zipper	#FFFFFF

Trims	Placement	Colour
Metallic belt buckle	Leg belts and belt straps, and back clousures	#C0C0C0 (SILVER)
Metallic belt eyelets	Leg belts and belt straps, and back clousures	#C0C0C0 (SILVER)
Metallic zipper	Main clousure	#D4AF37 (GOLD)

Thread	Placement	Colour
100% Cottom thread	Main body, legs and zipper	#FFFFFF













Conclusion

Despite the weird and extravagant character of the collection, the real purpose is a wake up call for all the people that are going through mental illnesses. Getting help is the first steep into recovery and we shouldn't be afraid of it, because at the end, everything will be worth, it's not going to be an easy road, but feeling good about yourself and your mental health is priceless.

Special thanks

To my tutor Jason, for encouraging me to keep improving my skills and to share my conceptual ideas with the world.

To my technicians Valentina and Anne, for all the help i got from them on the studio and for all the new things they taught me this year working with them

To my family and friends, specially my brother, who came from Spain to UK to help me with the shooting and the photoshoot of the collection.

To my girlfriend Natalia, for all the emotional and mental support, for taking care of me when i couldn't take care of myself and for all the help with the make up and the photoshoot.

Jason